

**ESPEC**

# TECHNOLOGY REPORT

Special issue:  
Evaluating Reliability

1997

---

No. **3**

---



## CONTENTS

### Understanding the Technology

What is Environmental Testing? Part 3 ..... 1

---

### Report 1

Confirming Reliability of Printed Circuit Boards with  
Temperature Cycle and Thermal Shock ..... 21

---

### Report 2

The Mechanism of Solder Cracking ..... 25

---

### Topics

Traceability Service ..... 30

---

## Our Philosophy

We at TABAI ESPEC are continually pursuing perfection. In our ongoing struggle to realize this ideal, we have established our Corporate Mind, which we proudly use as the basis for all our efforts. This Corporate Mind defines for us our present and future goals, directions and actions. At TABAI ESPEC, where "Environment" is our business, we offer aid for new technological developments and a more certain and improved living environment. With "Progress to Perfection" as our corporate policy, we aim to become the company, firstly "with public recognition by having our original line of business, and our own original product sphere by virtue of our original technology", and secondly "with intellectual *raison d'être* of such that as specialists can, assist our clients and industry in setting up various issues and in finding answers to them". This total concept we call ESPEC. From our internationally minded product development, to our thorough after-service, all our activities originate in this concept of ESPEC. ESPEC is the foundation upon which we manufacture products with superb performance, functional design and excellent cost-performance — our ESPEC.

**ESPEC — our philosophy, our goal.**

## Corporate Data

### TABAI ESPEC CORP.

**Company Name:** TABAI ESPEC CORP.  
**Date founded:** July 25, 1947  
**Date incorporated:** January 13, 1954  
**Paid-up Capital:** 6,778,900,000 Yen  
(As of March, 1996)

**Chairman:** Eiichi Koyama  
**President:** Kiyoshi Shimazaki  
**Senior Managing Director:** Yoshinobu Yamada  
**Managing Directors:** Susumu Nojii  
Toshikazu Adachi  
Nobuyoshi Shin

**Directors:** Toichi Ogura  
Katsuyuki Kakihara

**Auditors:** Katsuharu Nakano  
Shoichiro Yoshioka  
Takuichi Omura

**Employees:** 613 Persons

**Head Office:**  
3-5-6, Tenjinbashi, Kita-ku, Osaka 530, Japan  
Phone: (81) 6-358-4741  
Fax: (81) 6-358-5500  
Telex: 05233629 TBI J

**Kuala Lumpur Representative Office:**  
Temp Girl Business Center 4th. Floor,  
Secondary Tower Block Wisma MCIS,  
Jalan Barat 46700 Petaling Jaya,  
Selangor, Malaysia  
Phone: (60) 3-7544277  
Fax: (60) 3-7544290

**Beijing Office:**  
2 Xin Yuan Nan Lu,  
Chao Yang District, Beijing, China  
Phone: (86) 10-65941382  
Fax: (86) 10-65941383

**Guangzhou Office:**  
1 Zhu Si Gang, Dong Guan Zhuang Road,  
Guangzhou, China  
Phone: (86) 13-92206953  
Fax: (86) 20-87725041

**Metropolitan Area Office:**  
Yokohama (Kanagawa)

**Sales Offices:**  
Osaka, Tokyo, Yokohama, Sendai, Omiya,  
Tsukuba, Hino, Matsumoto, Shizuoka,  
Nagoya, Kanazawa, Hiroshima,  
Niihama, Fukuoka

**Plant:** Fukuchiyama (Kyoto)  
**Technical Center:** Neyagawa (Osaka)  
**Technocomplex:** Utsunomiya (Tochigi)

### The ESPEC Group (Affiliated Companies)

#### ESPEC CORP. (U.S.A.)

425 Gordon Industrial Court, S.W.  
Grand Rapids, MI 49509, USA  
Phone: (1) 616-878-0270  
Fax: (1) 616-878-0280

#### SHANGHAI ESPEC

#### ENVIRONMENTAL EQUIPMENT CORP. (CHINA)

Ha-mi Road 166 Shanghai, China  
Phone•Fax: (86) 21-62394953

#### GUANGZHOU ESPEC

#### ENVIRONMENTAL EQUIPMENT CO., LTD. (CHINA)

1 Zhu Si Gang, Dong Guan Zhuang Road,  
Guangzhou, China  
Phone: (86) 20-87745111  
Fax: (86) 20-87745223

#### C&E ENVIRONMENTAL TECHNOLOGY CO., LTD. (CHINA)

1 Zhu Si Gang, Dong Guan Zhuang Road,  
Guangzhou, China

#### TABAI ESPEC SERVICE CORP. (JAPAN)

#### TABAI KANKYO SETSUBI CO., LTD. (JAPAN)

#### TABAI ESPEC KYOTO CORP. (JAPAN)

#### TABAI ESPEC HYOGO CORP. (JAPAN)

## Product Guide

#### Environmental Test Chambers

Temperature (& Humidity) Chamber  
Temperature (Humidity) & Vibration  
Combined Environmental Test Chamber  
Walk-in Type Temperature (& Humidity) Chamber  
HAST System (Highly Accelerated Stress Test System)  
Thermal Shock Chamber  
Temperature Chamber (Industrial Ovens)  
Environmental Test Chamber Network, E-Bus

#### Burn-in Test Systems

ECL Testing Burn-in System  
Flash Memory E/W Cycle Test System  
Automatic Burn-in System

#### LCD Production Equipments

Automatic Clean Cure System  
Single Loading Plate Clean Oven

#### Laboratory Chambers

#### Biomedical Chambers

#### Agribusiness

Plant Factory  
Phyto-tron (Environmental Control Chamber for Plant)  
Growth Chamber

#### NOTE:

Some models are available only in the limited countries.

## What is Environmental Testing? Part 3

---

Yoshinori Kin\*1/Jyuro Izumi\*2

*Automotive electronics technology has been making astounding progress in recent years, and other types of mobile equipment, such as portable telephones and notebook computers, have become remarkably popular. Along with this, high-tech explosion has come a corresponding increase in the severity of the environments in which such equipment and parts are used, requiring much higher quality, and bringing much greater concern for safety and reliability. This combination of factors has prompted much greater interest in more severe testing such as “Thermal Shock Testing” and “Combined Environmental Testing”.*

*In the past two issues we have attempted to explain “Environmental Testing” in our series with Part 1 on “Temperature Testing” and Part 2 on “Humidity Testing”. In this article, the third and last in the series, we shall discuss “Thermal Shock Testing” and “Combined Environmental Testing”.*

### Contents

#### 1. Thermal Shock Testing

- 1-1 Summary of Testing
- 1-2 Examples of Failure Caused by Thermal Shock
- 1-3 Types of Thermal Shock Testing
- 1-4 Principal Standards for Thermal Shock Testing
  - 1-4-1 Names of Thermal Shock Tests
  - 1-4-2 MIL-STD-202F Test Methods for Electronic and Electrical Component Parts
  - 1-4-3 MIL-STD-883D Test Methods and Procedures for Microelectronics
- 1-5 Precautions for Thermal Shock Testing
- 1-6 Equipment for Thermal Shock Testing

#### 2. Combined Environmental Testing: Current Trends and Examples

- 2-1 Summary of Testing
- 2-2 Environmental Conditions for Combined Environmental Testing
- 2-3 Examples of Combined Environmental Testing
  - 2-3-1 Examples of Combined Environmental Testing for Transportation Environments
  - 2-3-2 Examples of Combined Environmental Testing for Usage Environments (Vehicular Equipment)
- 2-4 New Combined Environmental Testing Methods
  - 2-4-1 (Mechanical) Shock Testing
  - 2-4-2 Combined Multiaxial Testing
- 2-5 Summary
- 2-6 Equipment for Combined Environmental Testing

#### 3. Postscript

---

\*1 Overseas Business Department

\*2 Combined Environmental Test System Project

# 1. Thermal Shock Testing

## 1-1 Summary of Testing

As we mentioned at the beginning of this article, the level of reliability required for these products necessitates particularly severe testing. We would like to present the following reasons for that necessity.

- The miniaturization of parts and equipment makes items particularly susceptible to heat.
- Production processes may inflict serious heat stress, e.g., when reflow soldering.
- Parts receive increasingly greater heat stress due to higher product precision.
- The usage environment has become much harsher with the expansion of the automotive electronics field.
- Reliability requirements have become much more severe day by day.

In America, Thermal Shock Testing is often performed for 100 percent inspection before shipping as a form of screening. In Japan, Accelerated Testing is often performed as one aspect of reliability testing as a step in the development process. In either case, this testing aims to observe changes in characteristics as well as changes in failure occurrence caused by the differing coefficients of thermal expansion for the materials composing the parts. These changes are observed by exposing parts alternately to extremes of high and low temperatures.

Such applications form the basis for the increasingly crucial role Thermal Shock Testing is seen to play.

In actual processes such as during production and when actually using the product, thermal shock occurs in the following types of cases, which are often related to equipment failure.

- 1) Extreme rises in temperature may occur in reflow soldering processes.
- 2) Extreme rises in temperature of peripheral parts may occur when starting the engine, and in cold regions an extreme drop in temperature may follow stopping the engine.
- 3) Equipment may be carried from inside a warm room to cold outdoor temperatures, or from cold outdoor temperatures to warm indoor temperatures.
- 4) Equipment may be connected to the power source in a cold environment, resulting in a precipitous temperature gradient in the internal parts of the equipment. Disconnecting the power source in a cold environment may result in a precipitous temperature gradient in the opposite direction.
- 5) Equipment may be cooled abruptly by rainfall.
- 6) Equipment attached externally to aircraft may encounter abrupt temperature changes as the aircraft goes up to or comes down from high altitudes.

## 1-2 Examples of Failure Caused by Thermal Shock

We would like to present three examples of failure caused by thermal shock of commonly used electronic parts.

<Presentation: Chubu Electronics Development Association, "Study on Reliability of Printed Circuit Boards (sixth), — on Efficient Conditions of Thermal Shock Test. —">

### Example 1

Photos 1 and 2 show the section of the connector pin that has been dislocated. Due to the difference in the glass epoxy printed board (coefficient of thermal expansion:  $3.7 \times 10^{-5}$ ) and the connector resin (coefficient of thermal expansion:  $7.2 \times 10^{-5}$ ) to which the connector pin is attached, upward and downward forces are applied to the solder jointing by thermal shock, promoting solder cracking and connector pin dislocation.

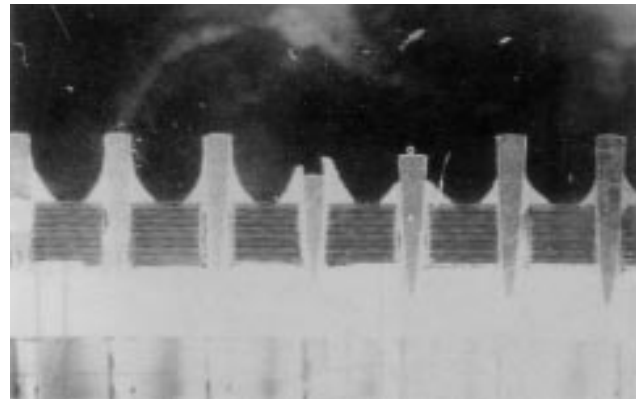

**Photo. 1** Cross section of area with dislocated connector pin

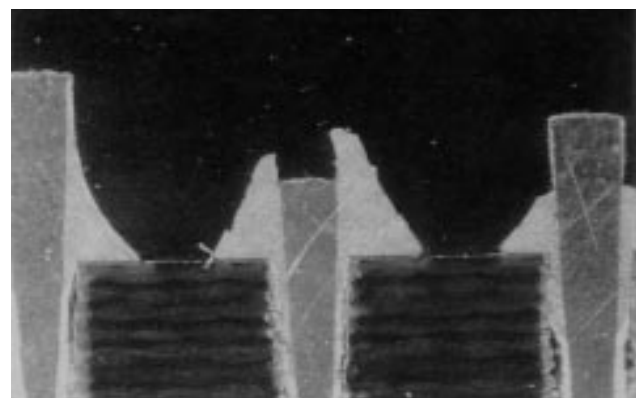

**Photo. 2** Enlargement of cross section of area with dislocated connector pin

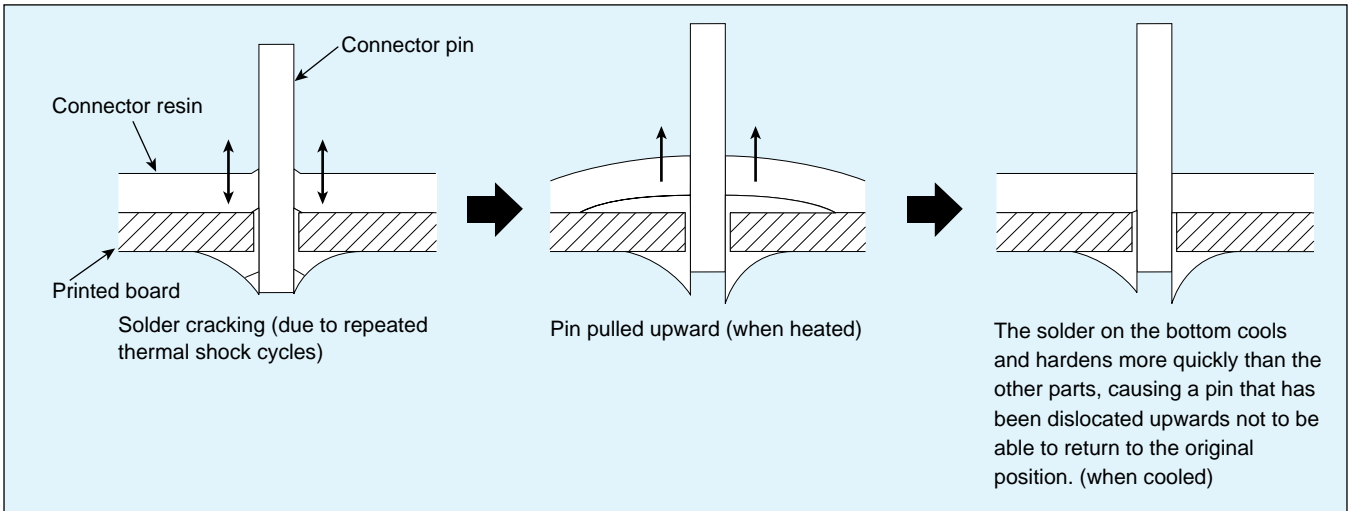

**Fig. 1 Pin dislocation mechanism (hypothetical)**

**Example 2**

Fig. 2 shows the internal composition of a resistance array. This resistance array has 8 components inside a single DIP package. Photo. 3 shows a normal resistance film, but Photos 4 through 7 show resistance array sections with resistance values increased or with infinite values, caused by thermal shock. All of these resistance films have been peeled from alumina substrate boards. When these receive thermal shock, the difference in coefficients of thermal expansion among the protective resin, resistance film, and the alumina substrate board causes repeated internal stress, and promotes resistance film cracking and peeling from the alumina substrate board.

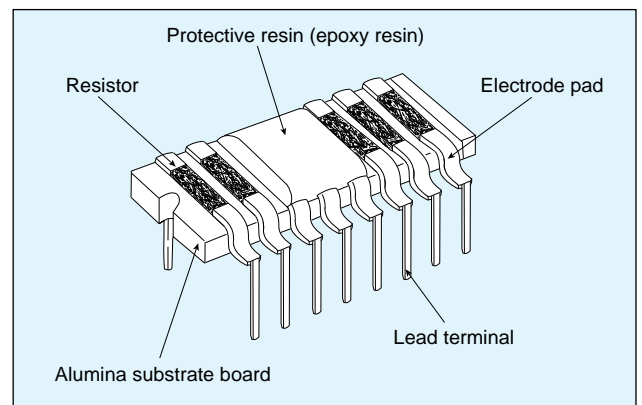

**Fig. 2 Internal composition of the resistance array**

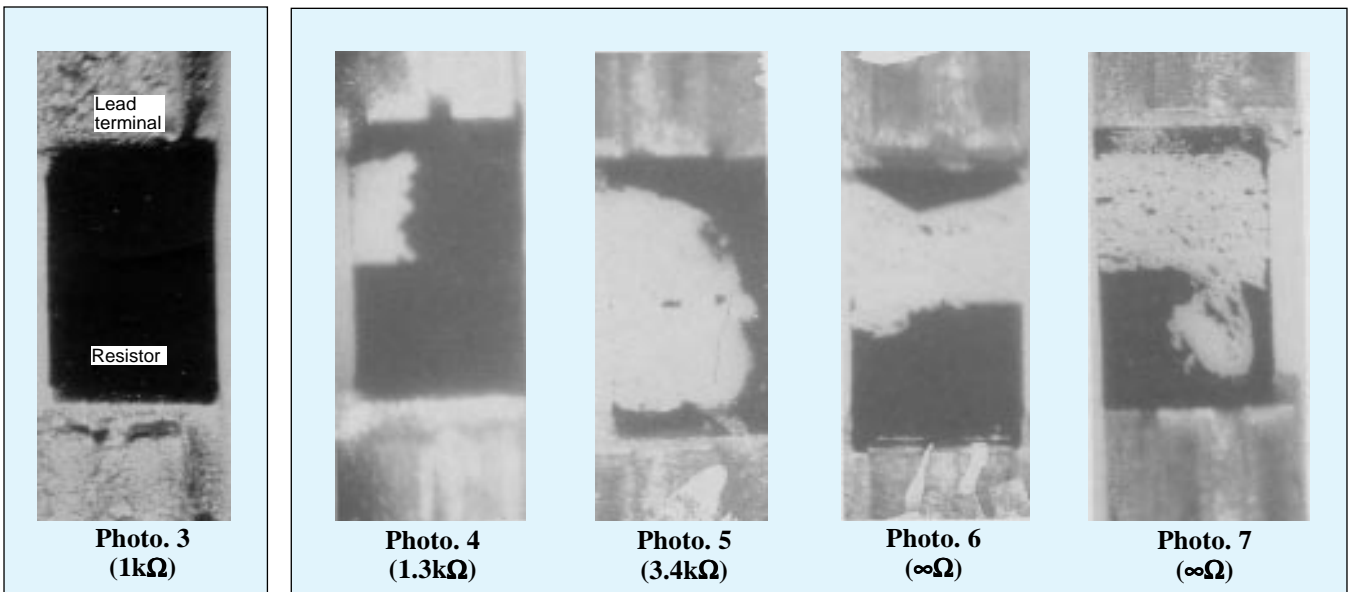

**Normal resistance film**

**Resistance film exhibiting peeling**

Values in ( ) show resistance value.

**Example 3**

Fig. 3 shows the composition of an LED bicolored light. In Photo. 8, both bonding Au wires are broken near the tip due to thermal shock. This is due to the differences in the coefficients of heat expansion for the tip, lead, and mold causing internal stress at the interface between the lead and the mold, and the interface between the tip and the mold. Such stress causes cracking and peeling and promotes breaking of the bonding Au wire.

These failures, peeling and by broken wires, have been caused by the physical force produced by the differences in coefficients of thermal expansion.

In America, the purpose for using Thermal Shock Testing for screening electronics parts is to discover defects before shipping. When design defects or manufacturing defects exist, the physical force applied by the Thermal Shock Testing finds the defects.

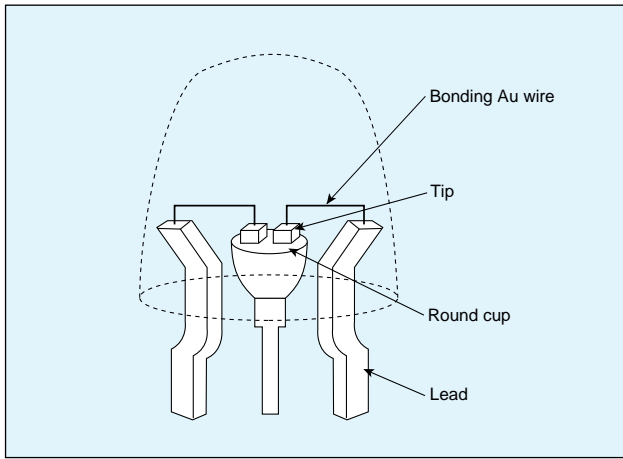

**Fig. 3 Composition of LED bicolored light**

### 1-3 Types of Thermal Shock Testing

Thermal Shock Testing can be divided into two main types. One type consists of an air chamber in which the specimen is alternately exposed to hot air and cold air. The other type consists of a liquid bath in which the specimen is alternately exposed to a hot liquid and a cold liquid.

Since the liquid in which the specimen is soaked in the liquid bath method has much greater heat capacity than air, the temperature of the specimen can be changed much more abruptly than with the air chamber method. Because of this, failures may appear in the liquid bath method that have not shown up in the air chamber method, and failures tend to appear earlier.

Fig. 4 shows changes in conductor resistance on Printed Wiring Boards (herein after called PWBs) caused by the air chamber method and by the liquid bath method. This graph indicates that the liquid bath method causes changes in characteristics at fewer cycles. (Details for the graph are given in "Report 1" of Technology Report No. 3.)

In addition, even supposing that failures were to occur at the same number of cycles in both the air chamber method and the liquid bath method, equivalent cycle time is much shorter in the liquid bath method. For example, in the MIL-STD-202F that we shall talk about later, when a specimen weighs 100 grams, exposure for 30 minutes in the air chamber method would equal exposure for 5 minutes in the liquid bath method, that is, results can be obtained in one-sixth the testing time. However, drawbacks for the liquid bath method include the extremely high cost of the liquid medium used in the bath, as well as such troubles as handling the liquid and cleaning the specimens after testing.

The air chamber method includes both the two zone method, repeatedly alternating between high and low temperatures, and the three zone method, repeatedly cycling from high to normal to low temperature and back again. The two zone method is the more severe of these, as it produces much more precipitous temperature changes.

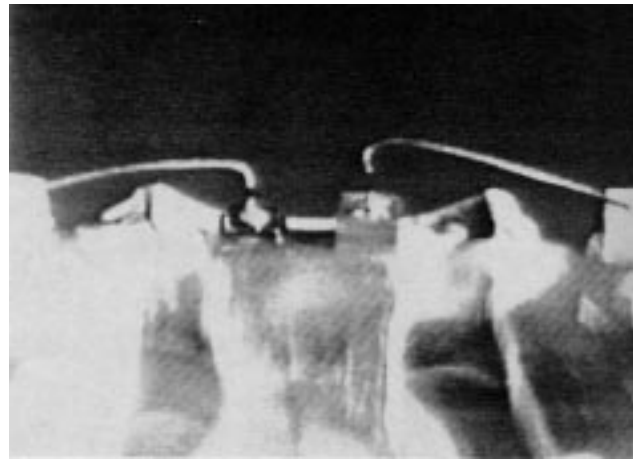

**Photo. 8 Cross section region of broken wire**

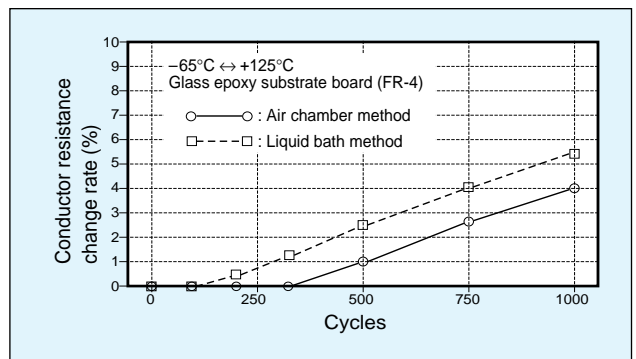

**Fig. 4 Changes in conductor resistance due to the air chamber method and the liquid bath method**

### 1-4 Principal Standards for Thermal Shock Testing

#### 1-4-1 Names of Thermal Shock Tests

Names of "Thermal Shock Tests" differ according to the standards used, so they must be properly identified. Listed below are the names for the major standards. In this article we will consolidate them as "Thermal Shock Testing".

MIL-STD-202F	(air chamber method)	Thermal shock
MIL-STD-202F	(liquid bath method)	Thermal shock
MIL-STD-810E	(air chamber method)	Temperature shock
MIL-STD-883D	(air chamber method)	Temperature cycling
MIL-STD-883D	(liquid bath method)	Thermal shock
IEC-Pub.68-2-14	(air chamber method)	Change of temperature
IEC-Pub.68-2-14	(liquid bath method)	Change of temperature

**1-4-2 MIL-STD-202F Test Methods for Electronic and Electrical Component Parts**

**Test Method: 107G Thermal shock**

(1) Air chamber method test conditions

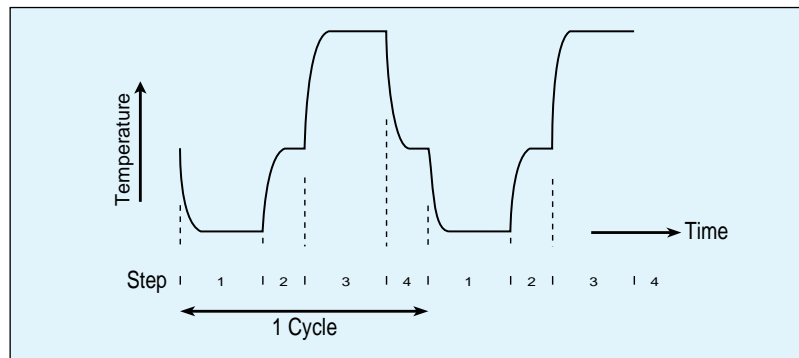

**Fig. 5 Test pattern of air chamber method**

**Table 1 Thermal shock testing conditions (air)**

Step	Test condition	Number of cycles	Test condition	Number of cycles	Test condition	Number of cycles
	A	5	B	5	C	5
Step	A-1	25	B-1	25	C-1	25
	A-2	50	B-2	50	C-2	50
	A-3	100	B-3	100	C-3	100
	Temperature (°C)	Time	Temperature (°C)	Time	Temperature (°C)	Time
1	$-55^{+0}_{-3}$	See table 2	$-55^{+0}_{-5}$	See table 2	$-65^{+0}_{-5}$	See table 2
2	$25^{+10}_{-5}$	5 minutes max.	$25^{+10}_{-5}$	5 minutes max.	$25^{+10}_{-5}$	5 minutes max.
3	$85^{+3}_{-0}$	See table 2	$125^{+3}_{-0}$	See table 2	$200^{+5}_{-0}$	See table 2
4	$25^{+10}_{-5}$	5 minutes max.	$25^{+10}_{-5}$	5 minutes max.	$25^{+10}_{-5}$	5 minutes max.

Step	Test condition	Number of cycles	Test condition	Number of cycles	Test condition	Number of cycles
	D	5	E	5	F	5
Step	D-1	25	E-1	25	F-1	25
	D-2	50	E-2	50	F-2	50
	D-3	100	E-3	100	F-3	100
	Temperature (°C)	Time	Temperature (°C)	Time	Temperature (°C)	Time
1	$-65^{+0}_{-5}$	See table 2	$-65^{+0}_{-5}$	See table 2	$-65^{+0}_{-5}$	See table 2
2	$25^{+10}_{-5}$	5 minutes max.	$25^{+10}_{-5}$	5 minutes max.	$25^{+10}_{-5}$	5 minutes max.
3	$350^{+5}_{-0}$	See table 2	$500^{+5}_{-0}$	See table 2	$150^{+3}_{-0}$	See table 2
4	$25^{+10}_{-5}$	5 minutes max.	$25^{+10}_{-5}$	5 minutes max.	$25^{+10}_{-5}$	5 minutes max.

**Table 2 Exposure time in air at temperature extremes**

Weight of specimen	Minimum time (for steps 1 and 3): Hours
1 ounce (28 grams) and below	1/4 (or as specified)
Above 1 ounce (28 grams) to 0.3 pound (136 grams), inclusive	1/2
Above 0.3 pound (136 grams) to 3 pounds (1.36 kilograms), inclusive	1
Above 3 pounds (1.36 kilograms) to 30 pounds (13.6 kilograms), inclusive	2
Above 30 pounds (13.6 kilograms) to 300 pounds (136 kilograms), inclusive	4
Above 300 pounds (136 kilograms)	8

The special features of this standard are as follows.

- a) Either the one or two chamber method can be used, but normal temperature exposure is not suited to the single chamber method.
- b) Exposure (dwell) time has been clearly determined according to specimen weight.
- c) Prescribed temperature can be reached within 5 minutes after moving the specimen.
- d) Specimens can be transferred within 5 minutes.
- e) Specimens must not be put directly in the path of forced circulation air while they are being moved.

(2) Liquid bath method conditions

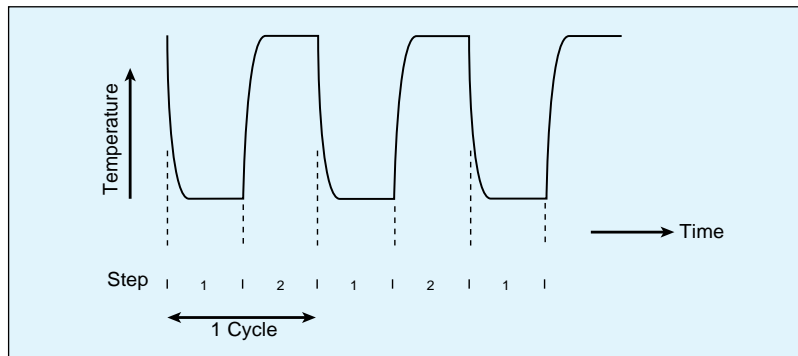

Fig. 6 Test pattern of liquid bath method

Table 3 Thermal shock conditions (liquid)

Step	Test condition	Number of cycles	Test condition	Number of cycles	Test condition	Number of cycles	Test condition	Number of cycles
	AA	5	BB	5	CC	5	DD	5
1	AA-1	15	BB-1	15	CC-1	15	DD-1	15
	AA-2	25	BB-2	25	CC-2	25	DD-2	25
	Temperature (°C)	Time	Temperature (°C)	Time	Temperature (°C)	Time	Temperature (°C)	Time
1	$-0^{+2}_{-10}$	See table 5	$-65^{+0}_{-10}$	See table 5	$-65^{+0}_{-10}$	See table 5	$-65^{+0}_{-10}$	See table 5
2	$100^{+10}_{-2}$	See table 5	$125^{+10}_{-0}$	See table 5	$150^{+10}_{-0}$	See table 5	$200^{+10}_{-0}$	See table 5

Table 4 Recommended fluid

Test Conditions	Condition A	Condition B	Condition C	Condition D
Step 1	FC-40 (or water) D02 D02-TS D/80	FC-77 D02 D02-TS D/80	FC-77 D02 D02-TS D/80	FC-77 D02 D02-TS D/80
Step 2	FC-40 (or water) D02 D02-TS D03	FC-70 FC-40 UCON-WS D02	D02-TS D03 FC-70 FC-40 UCON-WS D02	LS/230 LS/215 FC-70 FC-40 UCON-WS D02

Note:

- Ethylene glycol shall not be used.
- When using water as low temperature fluid, a mixture of water and alcohol may be used to prevent freezing.

Table 5 Exposure time in liquid at temperature extremes

Weight of specimen	Minimum time (for steps 1 and 2): Minutes
0.05 ounce (1.4 grams) and below	1/2
Above 0.05 ounce (1.4 grams) to 0.5 ounce (14 grams)	2
Above 0.5 ounce (14 grams) to 5 ounces (140 grams)	5

The special features of this standard are as follows.

- a) Exposure time has been clearly determined according to specimen weight.
- b) Specimens can be transferred within 10 seconds.
- c) Testing may not be interrupted during the prescribed cycles.



**1-4-3 MIL-STD-883D Test Methods and Procedures  
for Microelectronics**

(1) Test Method: 1010.7  
Temperature Cycling (air chamber method)

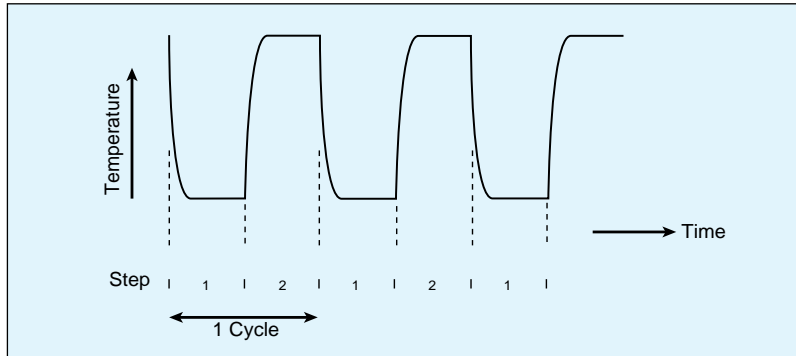

**Fig. 7 Test pattern of temperature cycling (air chamber method)**

**Table 6 Temperature-cycling test conditions**

Step	Minutes	Test condition temperature (°C)					
		A	B	C	D	E	F
<b>1 Cold</b>	≥ 10	-55 <sup>+0</sup> <sub>-10</sub>	-55 <sup>+0</sup> <sub>-10</sub>	-65 <sup>+0</sup> <sub>-10</sub>	-65 <sup>+0</sup> <sub>-10</sub>	-65 <sup>+0</sup> <sub>-10</sub>	-65 <sup>+0</sup> <sub>-10</sub>
<b>2 Hot</b>	≥ 10	85 <sup>+10</sup> <sub>-0</sub>	125 <sup>+15</sup> <sub>-0</sub>	150 <sup>+15</sup> <sub>-0</sub>	200 <sup>+15</sup> <sub>-0</sub>	300 <sup>+15</sup> <sub>-0</sub>	175 <sup>+15</sup> <sub>-0</sub>

**Note:**

Steps 1 and 2 may be interchanged. The load temperature may exceed the + or - zero (0) tolerance during the recovery time. Other tolerances shall not be exceeded.

The special features of this standard are as follows.

- a) The two zone method is used.
- b) Minimum exposure time after transferring specimens is 10 minutes.
- c) Worst case specimen recovery time is 15 minutes maximum.
- d) Specimens can be transferred within 1 minute.

(2) Test Method: 1011.9  
Thermal Shock (liquid bath method)

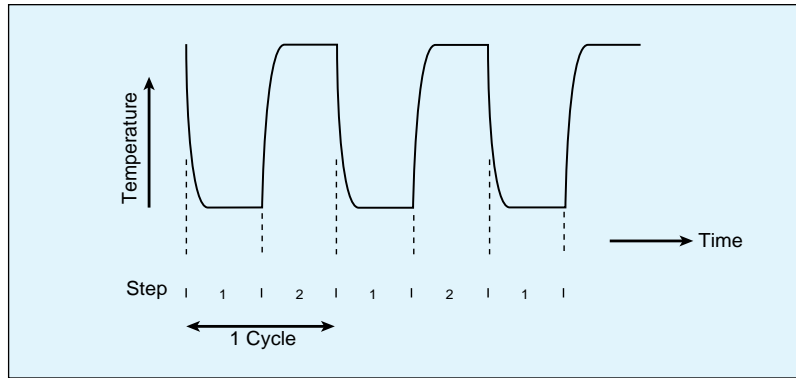

Fig. 8 Test pattern of thermal shock (liquid bath method)

Table 7 Thermal shock temperature tolerances and suggested fluids

Test conditions		A	B	C
		Temperature	Temperature	Temperature
Step 1	Temperature tolerance (°C)	100 <sup>+10</sup> <sub>-2</sub>	125 <sup>+10</sup> <sub>-0</sub>	150 <sup>+10</sup> <sub>-0</sub>
	Recommended fluid	Water	Perfluorocarbon	Perfluorocarbon
Step 2	Temperature tolerance (°C)	-0 <sup>+2</sup> <sub>-10</sub>	-55 <sup>+0</sup> <sub>-10</sub>	-65 <sup>+0</sup> <sub>-10</sub>
	Recommended fluid	Water	Perfluorocarbon	Perfluorocarbon

Table 8 Physical property requirements of perfluorocarbon fluids

Test conditions		B	C	ASTM test method
Step 1	Boiling point (°C)	>125	>150	D1120
	Density at 25°C (gm/ml)	>1.6		D941
	Dielectric strength (volts/mil)	>300		D877
	Residue (microgram/gram)	<50		D2109
	Appearance	Clear, colorless liquid		Not applicable
Step 2	Density at 25°C (gm/ml)	>1.6		D941
	Dielectric strength (volts/mil)	>300		D877
	Residue (microgram/gram)	<50		D2109
	Appearance	Clear, colorless liquid		Not applicable

**Note:**

The perfluorocarbon used shall have a viscosity less than or equal to the thermal shock equipment manufacturer's recommended viscosity at the minimum temperature.

The special features of this standard are as follows.

- a) Minimum exposure time is 2 minutes.
- b) Specimen temperature reaches prescribed temperature within 5 minutes.
- c) Specimens can be transferred within 10 seconds.
- d) Testing may not be interrupted during the prescribed cycles.
- e) The old test method 1011.7 recommended fluids for use, but the current standards make physical properties requirements for fluids.

\*Sections 1-4-2 and 1-4-3 give only a summary of the standards for reference. For details, consult the original standards.

## 1-5 Precautions for Thermal Shock Testing

### Example 1

Fig. 9 shows changes in conductor resistance when the PWB has undergone Thermal Shock Testing. The graph indicates that the greater the difference in temperature conditions, the quicker changes appear in characteristic values.

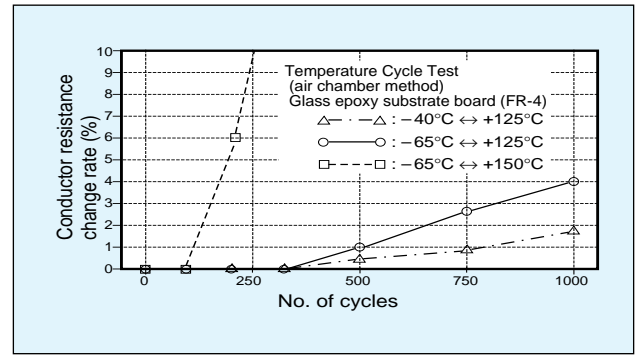
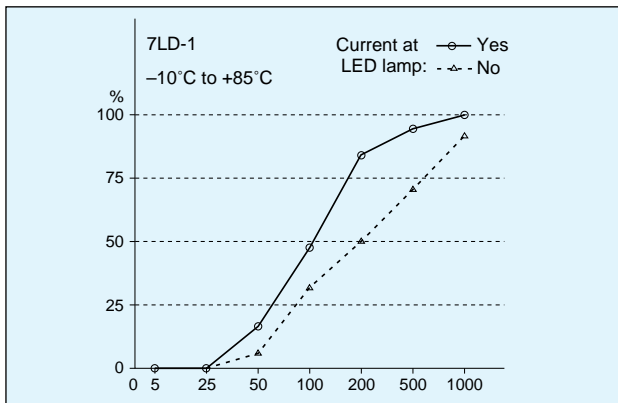

**Fig. 9** Changes in conductor resistance under different temperature conditions

### Example 2

Fig. 10 and 11 show the results of Thermal Shock Testing using the same temperature gap at different temperature settings for a 7 segment LED.

In this case, the maximum temperature can be assumed to accelerate failure more than the temperature gap.



**Fig. 10** -10°C to +85°C

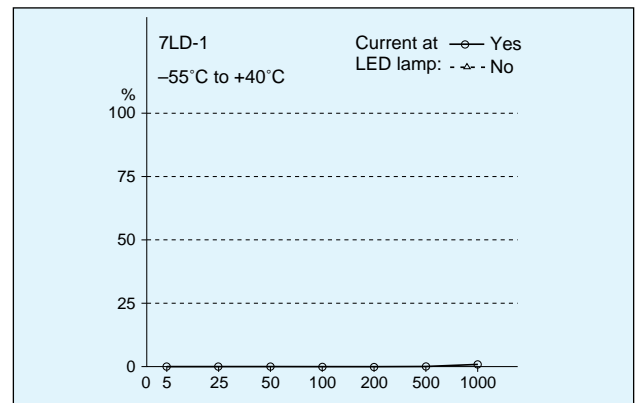
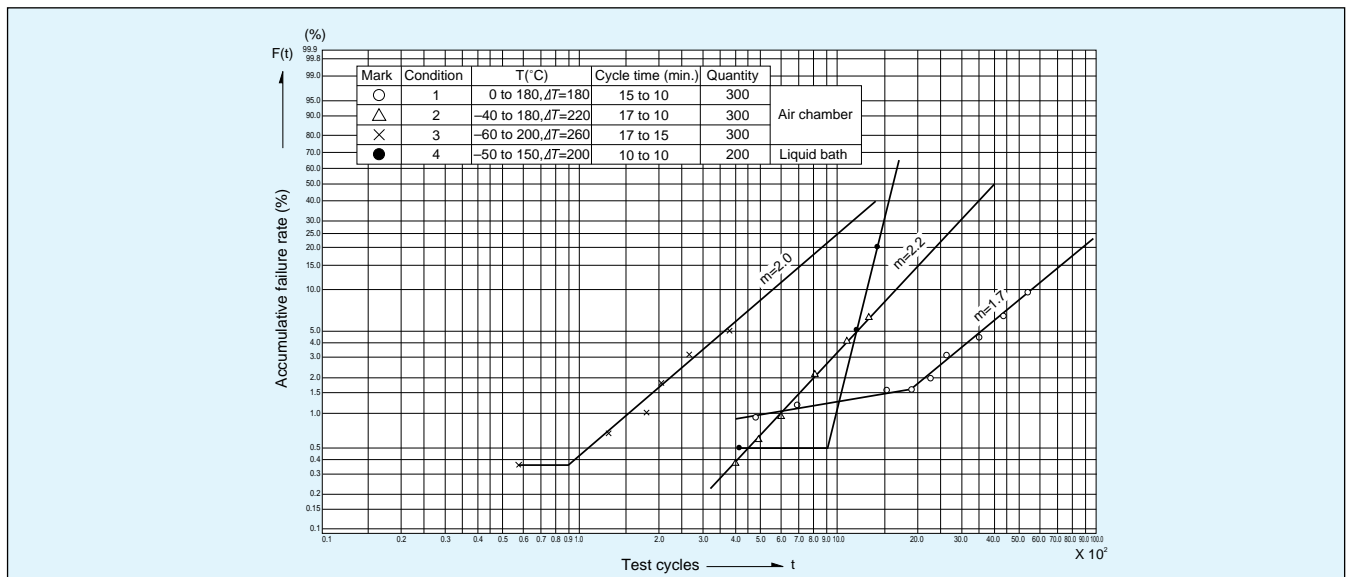

**Fig. 11** -55°C to +40°C

### Example 3

Fig. 12 shows the results of different test conditions for resin mold IC in performing Thermal Shock Testing. Under test conditions 1 the line turned up at approximately 1,700 cycles, and under test conditions 4 the line turned up at approximately 900 cycles, leading us to hypothesize a change in the failure mode.

<Presentation: Chubu Electronics Development Association, “Study on Reliability of Printed Circuit Boards (sixth), — on Efficient Conditions of Thermal Shock Test—”>



**Fig. 12** Results of resin mold IC Thermal Shock Testing

From these results, we can see that test outcomes vary widely depending on:

- Temperature differences in test conditions,
- Highest temperature, and
- Number of cycles

In addition, other conditions that exert major influence on test results include both “exposure time” and “temperature recovery time (temperature change rate)”.

To calculate “exposure time”, the internal parts of the specimen must also have reached the prescribed temperature. If exposure time is too short, only the surface of the specimen will receive thermal shock. Furthermore, if “temperature recovery time” is too long (that is, “temperature change rate” is small), differences in the coefficients of thermal expansion will not show up clearly, and expected test results will not be obtained. Also, when a large specimen is used, or when numerous specimens are tested at one time, the temperature recovery time will vary greatly depending on the position, so care must be taken with temperature measurement position and temperature control position.

Thermal Shock Testing is a severe test method even among the different types of environmental testing, and setting test conditions can be difficult. The correlation between test conditions and failures that occur in the field must be considered carefully to properly determine test conditions.

## 1-6 Equipment for Thermal Shock Testing

When selecting equipment for Thermal Shock Testing, one must of course consider reliability, maintainability, and ease of operation, but in addition, care must be taken with the following items.

### For the air chamber method:

- 1) Can appropriate temperature recovery time be obtained for specimen volume?
  1. Of course temperature recovery performance is affected by the position of the specimen. However, a large difference in recovery performance is problematic, so as far possible equipment with good temperature uniformity must be selected.
  2. Is the temperature control sensor positioned properly for test conditions?  
A temperature control sensor and temperature measurement sensor that can alternate either upstream or downstream of the specimen is preferable.
  3. Are auxiliary cooling methods such as liquefied carbon dioxide and liquefied nitrogen being used?
- 2) MIL-STD-202F Testing method 107G is a three-zone testing method that includes normal temperature exposure (Step 2, step 4).  
MIL-STD-883D Testing method 1010.7 is a two-zone testing method that doesn't include normal temperature exposure.  
Equipment can be either of the two-zone type or a type that can alternate between two-zone and three-zone testing. Equipment selection must be carefully based on testing conditions.

### For the liquid bath method:

- 1) Can appropriate temperature recovery time be obtained for specimen volume?  
**Note:** Since fluid with a high thermal capacity is usually stirred inside the chamber in the liquid bath method, major differences do not occur in temperature recovery time depending on the positioning of the specimen such as occur in the air chamber method.
- 2) Is the amount of fluid consumed small?

We would like to introduce the following products of our company, including those produced by our American subsidiary, ESPEC CORP.

**AIR-TO-AIR  
THERMAL SHOCK CHAMBERS TSA SERIES**



ESPEC's CFC free TSA Thermal Shock Chambers are newly designed with upgraded features and performance. True horizontal air-flow improves temperature and product gradient. The conditioned air is changed via a Damper System, which does not require the product to be moved. This design makes thermocoupling the product to movement which could produce vibration and shock.

An automatic vertical sliding door makes loading and unloading extremely easy and saves valuable floor space.

Model	Temperature range	Test area Volume cu. ft.	Test area dimensions W × D × H mm (in)
TSA-70H	High temp. chamber: +60 to +200°C (+140 to +392°F)	2.5	410 × 370 × 460 (16.1 × 14.6 × 18.1)
TSA-70S			410 × 370 × 460 (16.1 × 14.6 × 18.1)
TSA-100S	Low temp. chamber: -70 to 0°C (-94 to +32°F)	3.9	650 × 370 × 460 (25.6 × 14.6 × 18.1)
TSA-200S			650 × 670 × 460 (25.6 × 26.4 × 18.1)
TSA-40L	High temp. chamber: +60 to +200°C (+140 to +392°F)	1.4	240 × 370 × 460 (9.4 × 14.6 × 18.1)
TSA-70L		2.5	410 × 370 × 460 (16.1 × 14.6 × 18.1)
TSA-300L	Low temp. chamber: -65 to 0°C (-85 to +32°F)	10.6	970 × 670 × 460 (38.2 × 26.4 × 18.1)

**LIQUID-TO-LIQUID  
THERMAL SHOCK CHAMBERS TSB-2 TSB-5**



ESPEC has seen a great increase in demand for high-performance, high-intensity thermal shock chambers in many fields, especially in the electronics industry. Our liquid to liquid chambers are excellent for imposing high thermal stress on specimens. Operating costs are reduced as a result of lower fluid consumption achieved by the air-tight test chamber and an automatic rotary shutter at the bath inlet. Two types of fluid can be used by simply changing a valve. The dedicated AI controller can automatically determine appropriate pre-heating and pre-cooling as well as test conditions. These chambers also exhibit exceptionally short temperature change periods.

Model	Temperature range	Test area Volume cu. ft.	Test area dimensions W × D × H mm (in)
TSB-2	High temp. chamber: +70 to +200°C (+158 to +392°F)	0.08	120 × 120 × 150 (4.7 × 4.7 × 5.9)
TSB-5	Low temp. chamber: -65 to 0°C (-85 to +32°F)		150 × 200 × 150 (5.9 × 7.8 × 5.9)

## AIR-TO-AIR THERMAL SHOCK CHAMBERS ETS SERIES



These thermal shock chambers incorporate an innovative AI controller for precise test environment control and ease of operation. A large graphic LCD enables even the inexperienced operator to quickly set the test conditions simply by following the directions displayed. The controller also provides on-line help recommending corrective action during alarm conditions.

A wide range of performance is available, with a 22 lb (10 kg) load, of molded plastic ICs for example, the chambers demonstrate superlative temperature recovery characteristics recovering from +150°C/–65°C within 5 minutes using no auxiliary cooling. Multiple safety features guarantee the integrity of both specimen and chamber, and the advanced design achieves excellent maintainability by stressing ease of access for service.

Model	Temperature range	Test area Volume cu. ft.	Interior dimensions W × D × H mm (in)
ETS4-1SW	Hot box: Ambient to +210°C (Ambient to +410°F)	4	500 × 500 × 400 (20 × 20 × 16)
ETS4-2SW			
ETS4-3SW			
ETS13-3SW	Cold box: –75 to +40°C (–103 to +104°F)	13	660 × 830 × 630 (26 × 33 × 25)
ETS13-5SW			

## PWB CONDUCTOR RESISTANCE EVALUATION SYSTEM



Cracking in PWB through holes and solder junctions leads to broken wires and contact defects, which significantly degrade electronic product reliability. Both internal and external factors cause cracking. Internal factors include the method of contact, the solder quality, the type of flux activator, and the cleaning method. External factors include such environmental stress as temperature and humidity. The PWB Conductor Resistance Evaluation System detects cracking from changes in conductor resistance, through connecting the Thermal Shock Chamber with the Measurement System. This system can also be used for testing such contact equipment as connectors and switch relays.

(The photo shows a system example of the model with the Thermal Shock Chamber.)

Resistance measurement range	$10^{-3}$ to $10^4 \Omega$
Measurement time	approximately 4 seconds
Measurement range	10mΩ, 100mΩ, 1Ω, 10Ω, 100Ω, 1kΩ, 10kΩ
Measurement power	AC 1μA, 10μA, 100μA, 1mA, 10mA (rms)
Measurement frequency	1 kHz
Maximum applied voltage during measurement	20 mV
No. of measurement channels	40 points (maximum 280 points)

## 2. Combined Environmental Testing: Current Trends and Examples

### 2-1 Summary of Testing

Current products are being produced with an ever-increasing number of parts that are both miniaturized and require higher precision. As each product bears higher level functions, not only must parts be tested, but the final products must also undergo testing.

Testing serves to evaluate and guarantee product safety, durability, and reliability for the environments in which the products are used. By setting test conditions that are more severe than products encounter in actual use, testing can find product limits and defects, and can be used to select measures for improving product design.

Combined Environmental Testing uses multiple environmental factors for testing together, such as temperature and humidity cycles or low temperature and low pressure. However, in this report we would like to discuss ranges of testing under the combined conditions of temperature environment with vibration environment, and (temperature) humidity environment with vibration environment.

### 2-2 Environmental Conditions for Combined Environmental Testing

Combined Environmental Testing conditions include both the primary environment, which is a natural environment, and the secondary environment, which is an induced environment.

The natural environment, as implied by the expression, is one created by nature, and is determined by the season, altitude, and the specific site on the planet. Atmospheric environment factors predominate.

The induced environment is an artificial one in which the main environment is created by the base on which the part or product is shipped or used, and also by the surroundings (called the platform). Mechanical environment factors predominate. Fig. 13 shows the general factors (not limited to temperature, humidity, and vibration) for each environment.

In addition, when considering the shipping and usage environments as platforms, the relationship between the phenomena and environmental vibrations that occur in those platforms are shown in Fig. 14.

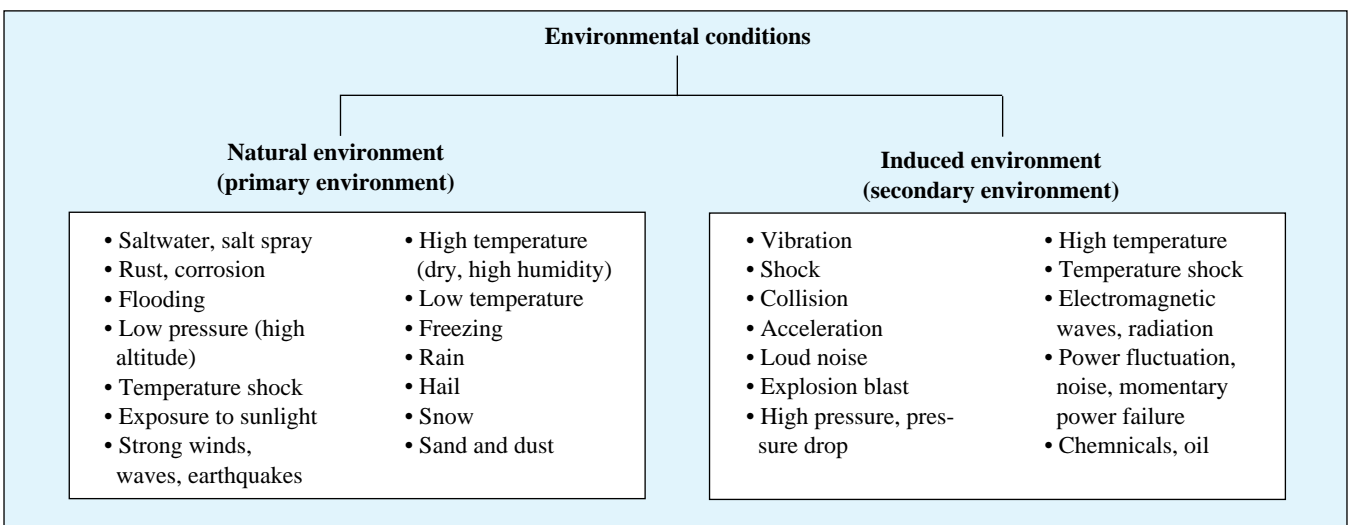











Fig. 13 Factors of environmental conditions in Combined Environmental Testing

Platform type	Relationship between the phenomena and environmental vibration
Shipping environment	 <b>Truck shipping</b> <b>Road vibration</b> — <b>RANDOM*1</b> Vibration from the roughness of the road surface is transmitted to the freight bed of the truck through the tires and suspension. Since the road surface is irregular, this vibration is random. <b>Road shock</b> — <b>SHOCK</b> The freight bed can receive shock from differences in road surface levels due to construction or to potholes in the road. <b>Freight handling shock</b> — <b>SHOCK</b> Shock from rolling, falling, dropping, or collision
	 <b>Railroad shipping</b> <b>Railroad vibration</b> — <b>RANDOM</b> Vibration is caused by the irregularity of the rails, and is transmitted through the suspension. This vibration is random. <b>Shunting shock</b> — <b>SHOCK</b> Shock from collisions between the freight cars when starting, stopping or connecting the freight cars. <b>Freight handling shock</b> — <b>SHOCK</b> Shock from rolling, falling, dropping, or collision
	 <b>Freighter shipping</b> <b>Wave vibration</b> — <b>SINE</b> Long waves that are equal to or longer than the length of the ship moves the entire ship in the form of a sine wave. If the characteristic (natural) frequency of the ship coincides with the wave, the ship can break at resonance peak. This long period sine wave vibration does not directly affect the freight. <b>Wave shock</b> — <b>SHOCK</b> Shock from breaking waves that hit the ship <b>Engine vibration</b> — <b>SINE ON RANDOM*2</b> <b>RANDOM ON RANDOM*3</b> Vibrations from diesel engines and turbine engines are transmitted to the freight as sine on random or random on random vibrations. <b>Freight handling shock</b> — <b>SHOCK</b>
	 <b>Air freight shipping</b> <b>Aerodynamic vibrations</b> — <b>RANDOM</b> Vibrations caused by turbulence on the main wings and body are random vibrations. <b>Engine vibration</b> Jet — <b>RANDOM</b> Propeller — <b>RANDOM ON RANDOM</b> Helicopter — <b>SINE ON RANDOM</b> <b>Landing shock</b> — <b>SHOCK</b> <b>Freight handling shock</b> — <b>SHOCK</b>

Platform type	Relationship between the phenomena and environmental vibration
Usage Environment	 <b>Portable products</b> <b>Freight handling shock</b> — <b>SHOCK</b> <b>Handling shock</b> — <b>SHOCK</b> <b>Environment identical to shipping environment</b> Without packaging materials
	 <b>Marine equipment</b> <b>Wave vibration</b> — <b>SINE</b> Ship construction <b>Wave vibration</b> — <b>SHOCK</b> <b>Engine vibration</b> — <b>SINE ON RANDOM</b> <b>RANDOM ON RANDOM</b>
	 <b>Aircraft equipment</b> <b>Aerodynamic vibration</b> — <b>RANDOM</b> <b>Noise vibration</b> — <b>RANDOM</b> <b>Engine vibration</b> Jet — <b>RANDOM</b> Propeller — <b>RANDOM ON RANDOM</b> Helicopter — <b>SINE ON RANDOM</b> <b>Landing shock</b> — <b>SHOCK</b> <b>Running vibration</b> — <b>RANDOM</b> <b>Emission vibration</b> — <b>SHOCK ON RANDOM</b>
	 <b>Automobile equipment</b> <b>Road vibration</b> — <b>RANDOM</b> Mainly equipment mounted on body <b>Engine vibration</b> Engine Transmission Equipment mounted on the intake/exhaust system — <b>SINE ON RANDOM</b> Inside the engine compartment — <b>RANDOM ON RANDOM</b> <b>Road shock</b> — <b>SHOCK</b> <b>Collision</b> — <b>SHOCK</b> Seats, vehicle body, air bag system, seat-belt system
	 <b>Stationary equipment</b> <b>Vibration from revolving equipment</b> — <b>SINE ON RANDOM</b>  <b>Stationary equipment</b> <b>Handling shock</b> — <b>SHOCK</b> <b>Handling collision</b> — <b>SHOCK</b>

\*1 RANDOM ..... Random vibration lacks periodicity, and it is impossible to put it into a formula on the time axis, so the probability density function of the vibration amplitude can be expressed as a near normal distribution power spectrum.

\*2 SINE ON RANDOM ..... In broadband pulse, multiple sine wave pulse occur simultaneously with the revolving pulse of the main driving power.

\*3 RANDOM ON RANDOM .... In broadband pulse, multiple random pulse occur simultaneously with the revolving pulse of the main driving power.

Fig. 14 Relationship between environmental vibration and phenomena occurring during shipping and usage



## 2-3 Examples of Combined Environmental Testing

When performing an actual test, generally one must determine both test time and test method.

To perform a test effectively, severe stress is applied to accelerate the chemical and physical causes of degradation of the parts and products. This acceleration reduces evaluation time and makes it possible to estimate the life and failure rate of the parts and products under the conditions in which they are used. When the products are actually shipped and failure occurs during shipping or during use, the causes of failure are not sought through normal standards testing. Tests that can recreate actual environmental conditions must be used to find the causes by forcing the failure to recur. On this occasion, Combined Environmental Testing must be carried out in a way that can be estimated to more faithfully reproduce the actual environment.

And now we would like to present examples of Combined Environmental Testing recreating the shipping environment and usage environment.

### 2-3-1 Examples of Combined Environmental Testing for Transportation Environment

At present, the field considered to be performing the most extensive Combined Environmental Testing in Japan is the automotive field.

Non-standardized tests on automotive parts are generally performed using test conditions designed according to decisions made by automotive manufacturers or parts manufacturers. For example, in SAE (Society of Automotive Engineers) standards the lower limit for temperature is  $-40^{\circ}\text{C}$ , and the vibration testing range is from 1 to 1000 Hz, and these are used as reference values for performing combined testing of temperature and vibration.

Conditions may be determined by shipping routes, as, for example, a variety of shipping routes are used for consumer durables. A diversity of shipping methods are also used, such as freighters, aircraft, railroads, and automobiles. Depending on the shipping method and the weather of each area, a variety of environments can be encountered during shipping.

For example, since the Gulf War, shipping from Japan to Europe via the Suez Canal has been changed to the Trans-Siberian Railroad, causing major changes in shipping environment variables such as temperature, humidity, and vibration. An explication of the product complaints arising from this shipping route are an excellent example of the power of Combined Environmental Testing.

To test packaging for shipping via the Trans-Siberian Railroad, we used long-term shelf storage at  $-40^{\circ}\text{C}$ , and then we added power spectrum random vibration testing determined by the shipping conditions. We used this kind of Combined Environmental Testing to obtain our results.

Next, we would like to present some examples of that testing.

## Combined Environmental Testing of equipment shipped by rail (example)

Packages with heat sinks installed on electronic parts were arriving in Europe with defects (the legs were broken off) caused by the heat sink weight, and so various kinds of tests were performed. Testing confirmed that vibrations at low temperature could reproduce the defect.

### Summary of Test Methods

- 1) Parts and equipment subject to testing were any specimens shipped on the Trans-Siberian Railroad. In addition, items planned for future shipping were included for testing.
- 2) Conditions and Testing
  1. Parts and equipment were testing in their final shipping packaging. (specimens included both those packaged individually and those in cartons.)
  2. Number of specimens were one or more at random.
  3. Specimens were placed on the shipping platform without being fastened in place, and vibration testing was performed using the following conditions. The direction of vibration amplitude was limited to vertical only, but when the number of samples was  $n = 3$  or more, vibration amplitude was permitted in 3 directions.
    - Vibration/Driving time  
Vibration frequency ..... 5 to 50 Hz  
Power spectral density .....  $0.015 \text{ G}^2/\text{Hz}$   
Overall r.m.s. value ..... 0.83 G  
(random wave vibration)  
Vibration time ..... 46 minutes
    - After maintaining  $-40^{\circ}\text{C}$  for at least 5 hours, vibration was applied in the  $-40^{\circ}\text{C}$  environment.
  4. After low temperature vibration testing is finished, temperature recovers to normal temperature, and specimens are left at normal temperature for a minimum of 3 hours. Finally, parts are checked for abnormalities, including changes in appearance, general operation, and an internal parts inspection.

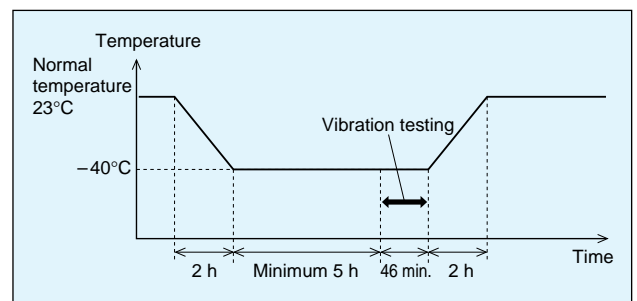

Fig. 15 Example of Combined Environmental Testing of equipment shipped by rail

### 2-3-2 Example of Combined Environmental Testing for Usage Environment (Vehicular Equipment)

An increasingly large number of car electronics parts are used in modern vehicles.

The ECU (Electronic Control Unit, with a built-in microcomputer) in modern automobiles performs reliability evaluation testing including Combined Environmental Testing set by the internal standards of each manufacturer.

Since the operating environment of the ECU is the vehicle, conditions for failure analysis need to be as close to actual vehicular running conditions as possible, proliferating manufacturers who produce Combined Environmental Testing equipment. Introductory studies have begun on the “multiaxial simultaneous vibration + random vibration + combined temperature and humidity chamber” as a unit that can perform Combined Environmental Testing at conditions resembling those in the actual environment.

Next, we would like to present some examples of that testing.

#### Example 1 Combined Environmental Testing of vehicle audio equipment

When an automotive heater is turned on after a car has been parked in a cold area, such as at a ski resort, the vehicle audio system bears the stress of an abrupt change in temperature. One manufacturer has performed Combined Environmental Testing that considers vibration after the car has been started in these conditions.

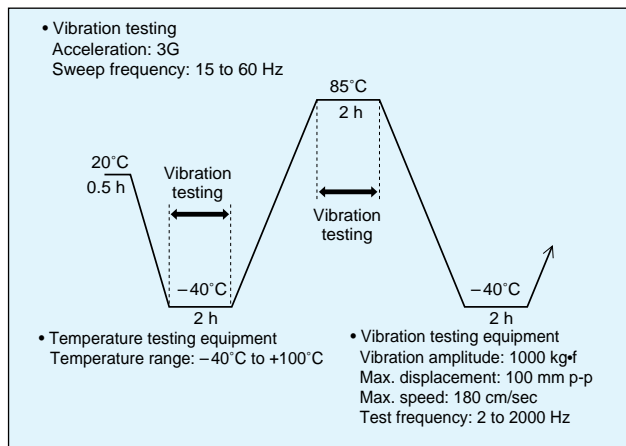

Fig. 16 Example of Combined Environmental Testing of vehicle audio equipment

### Example 2 Combined Environmental Testing of assembly unit with air bag sensor

Because of the emphasis on improving safety in recent years, air bag systems have become common to protect passengers in vehicle collisions. Combined Environmental Testing is performed to confirm the reliability of the assembly unit with sensor used in these air bag systems.

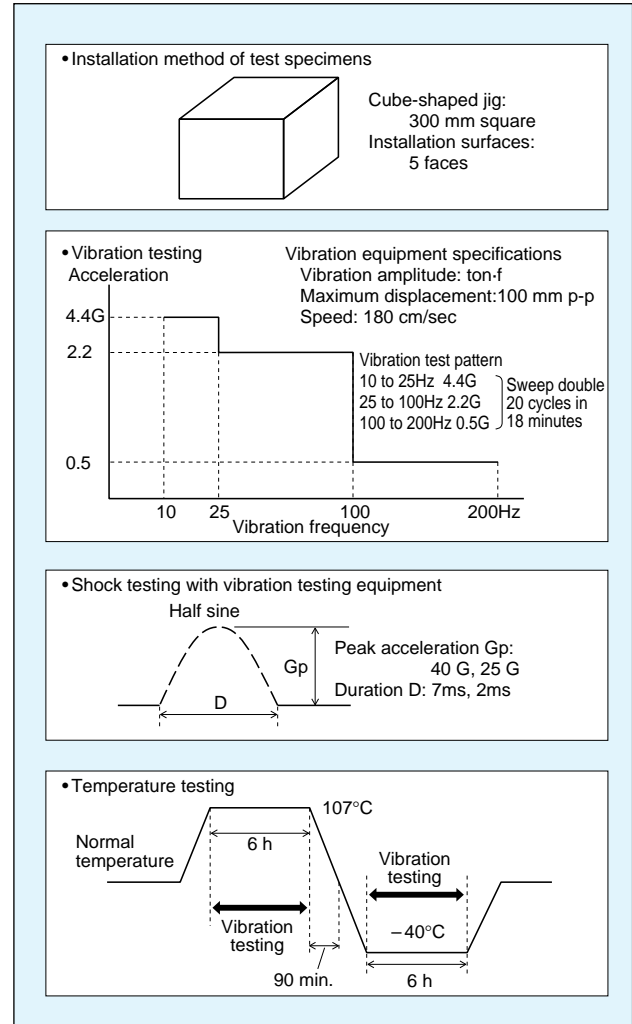

Fig. 17 Example of Combined Environmental Testing of assembly unit with air bag sensor

## 2-4 New Combined Environmental Testing Methods

With recent advances in controllers for vibration testing, tests can not only do sine wave vibration testing, but can also do random wave and shock wave testing. By connecting several vibration generators to the vibration platform, a system has been developed that can be switched among multiple axes (X, Y, and Z). Another system has been developed that can simultaneously vibrate all three axes, and should become widely employed in the 90's. Shipping environment reliability can be evaluated more effectively using testing that resembles actual vibration experienced during shipping. This kind of testing can be performed with a Combined Environmental Test System using temperature (humidity) environment with multiaxial vibration. At present, however, testing methods for closely duplicating actual environments are just beginning to be widely adopted.

### 2-4-1 (Mechanical) Shock Testing

Standards for shock testing methods, such as test method 213 of MIL-STD-202F (Test Methods for electronic and electrical component parts), and JIS-C-0041 (1995), 0042 (1995), clarify testing aspects such as purpose, methods, and range of application.

Conventional Shock Testing uses machines to generate shock with such methods as free fall and elastic rebound. For special purpose products (e.g., missile bodies and missile guidance equipment), one method is to perform MIL standards half sine shock testing using a large Water-cooled Vibrating Test System (vibration amplitude force 8 to 30 ton-f).

As ever more powerful shock testing methods are being developed, Shock Testing is being adopted for many parts and products. Powerful Shock Testing has become possible through the development of maximum 3000 kg-f air cooled electrodynamic vibrators with long stroke (40 to 100 mm P-P, low cost multifunctional controllers (sine, shock, random) and switching methods utilizing high power amplifiers. This type of equipment has made possible top speeds of up to 200 cm/sec.

### Types of shock parts and products receive

Portable equipment such as video cameras and mobile audio devices

..... Shock received while being carried

Automotive CD, display meters, displays, ECU

..... Shock received while driving

Automotive harnesses, connectors, tail lamps

..... Shock received when opening or closing doors and trunk

Computer CD-ROMs and hard disk drives

..... Shock received during operation

Combined Environmental Testing using sine and random vibration together has been used on these parts and products, but more recently Shock Testing has also become possible by combining low cost digital controllers with electrodynamic vibration testers. Concurrently, requirements for Combined Shock Testing have also been increasing. Special characteristics of integrated dampers, which aim to reduce shock and vibration from external sources, are affected by temperature, and parts and products need to have vibration resistance evaluated using Combined Environmental Testing.

Vibration testing performed as one aspect of Combined Environmental Testing can consist of components from sine wave testing to random wave testing and shock testing. This provides combined testing that more closely resembles the actual environment, creating evaluation testing conditions closer to ideal conditions, and making endurance testing possible.

Photo. 9 shows an example of delivery of a Combined Environmental Test System. Here, the TABAI ESPEC Temperature/Humidity Chamber is connected to the Vibration Generator using the chamber bottom direction connection method.

Compared with the connecting shaft method, this chamber bottom direction connection method:

- Has no acceleration loss due to the added weight of the connecting shaft.
- Has a ceiling frequency that fulfills performance specifications of the vibrating system.
- Has the advantage of being easier to operate with lower specimen installation section where the connecting shaft is not needed.



**Photo. 9** Vibration generator connected to temperature/humidity chamber

### 2-4-2 Combined Multiaxial Testing

The vibration parts and products receive during shipping is not limited to simple one direction vibration. Vibration can occur simultaneously in two or three directions (X, Y, and Z axes).

Vibration-induced loss has become of greater concern due to the increasingly high performance levels of parts and products now in use for aircraft and automobiles, electric and electronic parts, and items with structural and architectural applications. Such high performance levels mean that reliability must be pursued through testing conditions that are much more severe than public standards. Vibration test environments must more closely reflect actual environmental conditions, and so multiaxial, multidimensional vibration testing equipment is becoming more and more widely used.

One example of this is the cobblestone roads in Europe that cause a severe up/down vibration creating abnormalities in the sound field environment of the vehicle interior. One manufacturer performed testing that recreated the vibration of the actual driving environment, resulting in their being able to improve quality.

Low frequency range vibration testers were developed early for shipping package testing used on large heavy items.

Also, conventional single axis vibration generators had to be changed over from horizontal to vertical during testing, making it necessary to perform the following complex operation.

- 1) Remove specimens.
- 2) Dismantle horizontal vibration platform.
- 3) Rotate vibration generator 90 degrees.
- 4) Couple vertical vibration platform.
- 5) Install specimens.

And further, since the vertical and horizontal vibration platforms are not the same height, in some cases preparations had to be made for connecting each with the temperature/humidity chamber.

MIL, JIS, and IEC standards testing is now possible using high frequency, high acceleration generation at the same level as with single axis vibration equipment.

Specimens tested together on the same table can be vibrated vertically and horizontally without re-setup of the stage or changeover, and can be switched from single direction vibration to two or three directions by connecting one temperature/humidity chamber. This ease of operation makes combined multiaxial testing possible using simultaneous multidimensional vibration.

On Multiaxial Vibration Test Systems, simply flipping a switch enables changing between vertical and horizontal vibration. Testing has also become possible on two and three axes simultaneously. Setting the time sequence enables endurance testing interconnecting the vertical and horizontal axes while linked to the temperature and humidity chamber. This testing can be performed with the same installation, without stopping the chamber, without setting up the stage again, and without changing the specimens.

Fig. 18 shows an example of multiaxial stress, and Photo. 10 shows an equipment sample.

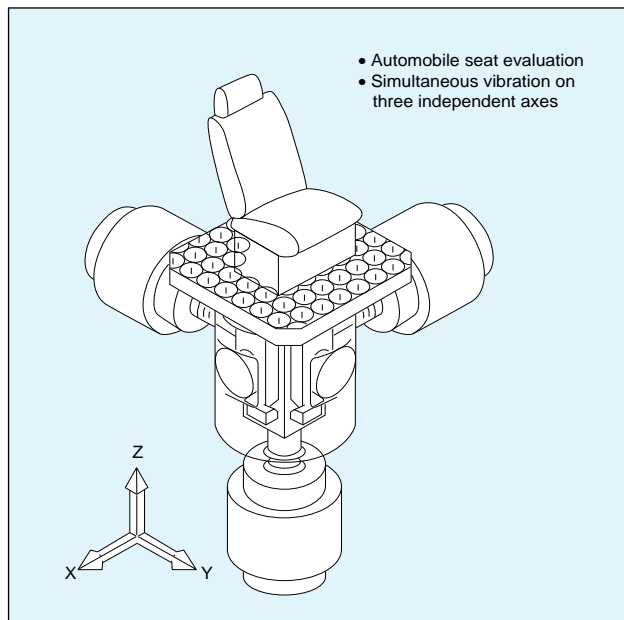

Fig. 18 Multiaxial stress



Photo. 10 Multiaxial Combined Environmental Test System

## 2-5 Summary

The driving force behind current industrial product development includes high level functions, higher reliability, lower electrical consumption, and lower cost. These benefits have been made possible by the development of LSI technology, surface mounting technology, and liquid crystal displays. Sensor actuators and ECUs have provided great strides in car electronics technology, and vehicle equipment has become increasingly miniaturized and the number of products has increased. Mobile unit communications and portable AV equipment is becoming ever more rapidly adopted.

This type of market development creates the following demands.

- 1) Demand is growing for safety and reliability to be more widely guaranteed for high-tech specialist equipment that is increasingly being marketed for the general consumer.

- 2) The accelerating pace of technical innovation reduces development time for new products, making faster reliability evaluation ever more crucial.
- 3) To reduce the incidence of early failure, it is becoming more and more critical to eliminate defects in the production process and to actualize latent defects of devices.
- 4) Strong demand exists for ways to improve the ability to analyze failure due to combined environmental factors.

Reliability testing must become more accurate and evaluation must become faster to improve the ability to efficiently analyze market complaints. The role played in this process by Combined Environmental Testing is becoming more important, and we expect even greater developments in this field of technology in days to come.

## 2-6 Equipment for Combined Environmental Testing

### TEMPERATURE (HUMIDITY) AND VIBRATION COMBINED ENVIRONMENTAL TESTING CHAMBER



This environmental testing chamber creates combined environmental stress by combining atmospheric environmental stress such as temperature and humidity with physical (mechanical) environmental stress such as shock, vibration, and acceleration.

Model	Temperature and humidity range	Internal dimensions W × H × D mm (in)
PVL-2SP	-40 to +100°C (-40 to +212°F) 20 to 98%RH	500 × 750 × 600 (19.7 × 29.5 × 23.6)
PVL-3SP		600 × 850 × 800 (23.6 × 33.5 × 31.5)
PVL-4SP		1000 × 1000 × 800 (39.4 × 39.4 × 31.5)
PVS-2SP	-70 to +100°C (-94 to +212°F) 20 to 98%RH	600 × 850 × 600 (23.6 × 33.5 × 23.6)
PVS-4SP		1000 × 1000 × 800 (39.4 × 39.4 × 31.5)
PVU-2SP	-40 to +100°C (-40 to +212°F)	500 × 750 × 600 (19.7 × 29.5 × 23.6)
PVU-3SP		600 × 850 × 800 (23.6 × 33.5 × 31.5)
PVU-4SP		1000 × 1000 × 800 (39.4 × 39.4 × 31.5)
PVG-2SP	-70 to +100°C (-94 to 212°F)	600 × 850 × 600 (23.6 × 33.5 × 23.6)
PVG-4SP		1000 × 1000 × 800 (39.4 × 39.4 × 31.5)

Model	Applied vibration force	Maximum load*	Model	Applied vibration force	Maximum load*
V1	120kgf	66kg	S1S	100kgf	66kg
V2	200kgf		S2S	200kgf	116kg
V3	300kgf	116kg	S3S	300kgf	
V4		122kg	S4S		
V5S	600kgf	192kg	S5S	500kgf	196kg
V6S	1000kgf	242kg	S6S	1000kgf	192kg
V7S		120kg	S7S		292kg
V8S	1500kgf	290kg	S8S	1500kgf	
V9S	2000kgf		S9S	2000kgf	
V10S	3000kgf	492kg	S10S	3000kgf	

\*Vibration generator performance when performing Combined Environmental Testing

### COMBINED ENVIRONMENTAL RELIABILITY TESTING CHAMBER CERT SERIES



This reliability testing chamber reproduces individual or combined environments to test temperature vs. pressure, vibration vs. pressure, or temperature vs. pressure vs. vibration. This chamber is used for such reliability testing as aircraft and spacecraft parts and materials.

Model	Temperature and pressure range	Internal dimensions W × H × D mm (in)
CERT-22	-70 to +100°C (-94 to 212°F)/ 101 to 19 kPa (760 to 140 Torr)	1500 × 1000 × 1500 (59 × 39.4 × 59)
CERT-33	-70 to +100°C (-94 to 212°F)/ 101 to 7 kPa (760 to 54 Torr)	1500 × 1500 × 1500 (59 × 59 × 59)

### 3. Postscript

We have presented a three part series on environmental testing technology, with “Temperature Testing” in Part 1, “Humidity Testing” in Part 2, and both “Thermal Shock Testing” and “Combined Environmental Testing” in Part 3. We sincerely hope that everyone involved in leading edge research and technology development will find knowledge of environmental testing to be useful.

From our next issue we will begin a series on environmental testing from the standpoint of reliability testing, and we believe you won't want to miss it.

We shall be very pleased if you continue to find our articles worthwhile.

#### [Reference Bibliography]

- 1) “Study on Reliability of Printed Circuit Boards (sixth), — on Efficient Conditions of Thermal Shock Test —”, Chubu Electronics Development Association
- 2) “Reliability Testing: Outline and Equipment Parts”, Union of Japanese Scientists and Engineers
- 3) “Bibliographical Investigative report on Combined Environmental Testing”, Kansai Electronic Industry Development Center (1986)
- 4) “Environmental Testing Methods (Vibration, Shock) and Their Problems”, IMV Corporation TP-930

## Confirming Reliability of Printed Circuit Boards with Temperature Cycle and Thermal Shock

Hirokazu Tanaka\*/ Yuuichi Aoki\*/Shigeharu Yamamoto\*

*Changes in our modern way of life have fostered the miniaturization of electronic appliances and their use in a wide variety of environments. This miniaturization of electronic appliances has increased the mounting density of PCB (printed circuit boards) and has narrowed the tolerance between conductors to minute gaps. On the other hand, the diversity of environments in which this equipment is used has brought on numerous types of environmental stress to PCBs. When heat stress and mechanical stress are applied to the minute gaps between conductors, such stress causes openings in the wiring pattern and results in part failure.*

*In this report, to confirm the effects of heat stress on PCB through holes, we performed the Temperature Cycle Test (air chamber method) and the Thermal Shock Test (liquid bath method). As a result, we found a strong relationship between solder cracking and the life of the copper-plated through hole. In addition, we shall report on our confirmation of the mechanism leading to that failure life.*

### 1. Introduction

The increasingly broad range of applications for electronic appliances has introduced PCBs into all sorts of fields where they are used under a wide variety of conditions. In addition, wiring patterns have narrowed and through holes have become smaller due to the miniaturization of on-board parts, as well as high-density sur-

face mounting. These factors make maintaining the reliability of PCBs increasingly vital.

In this article, we shall report on testing and analysis of degradation of PCB through holes due to temperature cycle and thermal shock.

### 2. Reliability and Test Method for Copper-plated Through Holes

The degradation of copper-plated through holes shows up as cracking and breaking in the plating caused by heat stress and mechanical stress.

During heat stress, the differences in thermal expansion in the various materials such as copper, the board (resin), and the solder bring repeated stress to bear on the copper-plated section.<sup>1), 2)</sup> For this investigation, we performed the Temperature Cycle Test (air chamber method) and Thermal Shock Test (liquid bath method). We analyzed the failure mechanism through changes in the characteristic values as well as through observation of cross sections.

The specimen for testing was a glass epoxy substrate board (USA NEMA standard No. FR-4) with continuously connected landless plated through holes as shown in Fig.1. Table 1 shows test conditions. The test investigated the changes in characteristic values and failure modes depending on the presence or absence of solder in the through hole, as well as the test temperature and temperature change time. Changes in the conductor resistance of the substrate board were measured with a milli-ohm meter. In addition, cross section observation was carried out by impregnating the through hole with resin, cross sectioning, and observing with a metallurgical microscope.

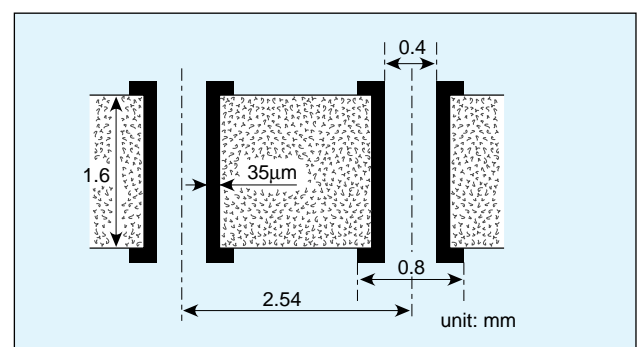

Fig. 1 Through hole shape

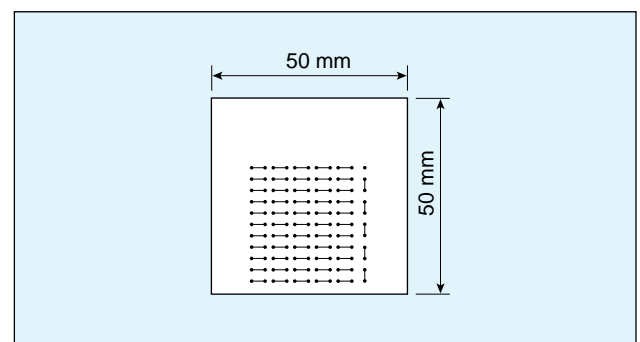

Fig. 2 Substrate board pattern

\*Environmental Test Technology Center

**Table 1 Test Conditions**

Test Purpose	Test Items	Pretreatment	Test Conditions
Difference with or without solder	Temperature Cycle Test (air chamber method)	○	-65°C ↔ +125°C, 30 min. each, 1000 cycles
		×	
Difference due to temperature (with solder)	Temperature Cycle Test (air chamber method)	○	-40°C ↔ +125°C, 30 min. each, 1000 cycles
			-65°C ↔ +125°C, 30 min. each, 1000 cycles
			-65°C ↔ +150°C, 30 min. each, 1000 cycles
Difference due to temperature change time (with solder)	Temperature Cycle Test (air chamber method)	○	-65°C ↔ +125°C, 30 min. each, 1000 cycles
	Thermal Shock Test (liquid bath method)		-65°C ↔ +125°C, 5 min. each, 1000 cycles

\*Pretreatment: solder heat resistance test, 260°C, 10 seconds, solder: 63 Sn wt%

### 3. Test Results

#### 3-1 Differences With and Without Solder

Fig. 3 shows changes in through hole conductor resistance. The failure mode in both instances, determined through cross section observation, was found to be corner cracking of the copper plated section. Furthermore, degradation proceeded more rapidly with solder present, so we can assume solder is related to the progression of cracking. (Photo. 1)

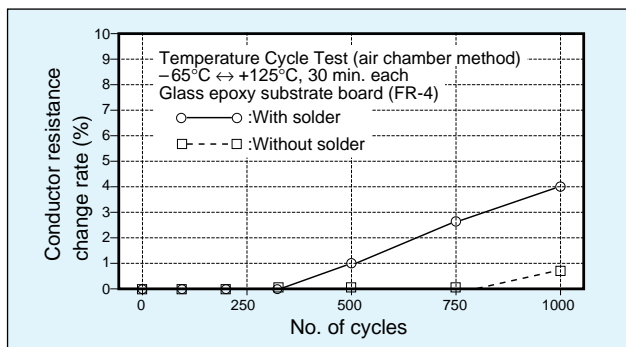

**Fig. 3 Changes in conductor resistance with and without solder**

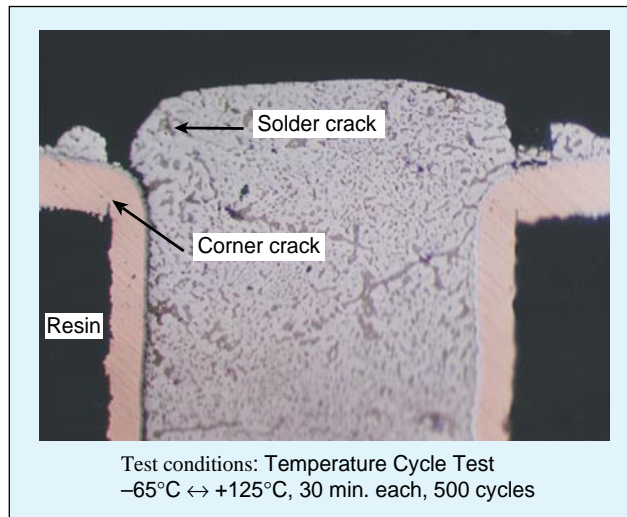

**Photo. 1 Cross section observation results (with solder) (200×)**

#### 3-2 Differences Due to Temperature Conditions

Fig. 4 shows changes in conductor resistance due to each temperature condition, and Photo 2 shows results of cross section observation occurring at 500 cycles under each set of conditions. The results confirm that the failure mode under each set of conditions is caused by corner cracking of the copper plated section, and that the greater the temperature difference, the faster the progress of the degradation.

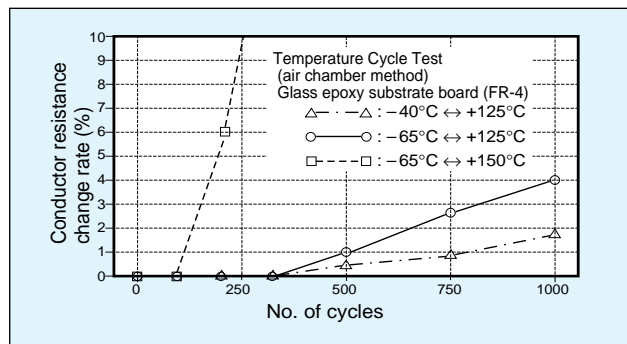

**Fig. 4 Changes in conductor resistance for each temperature**



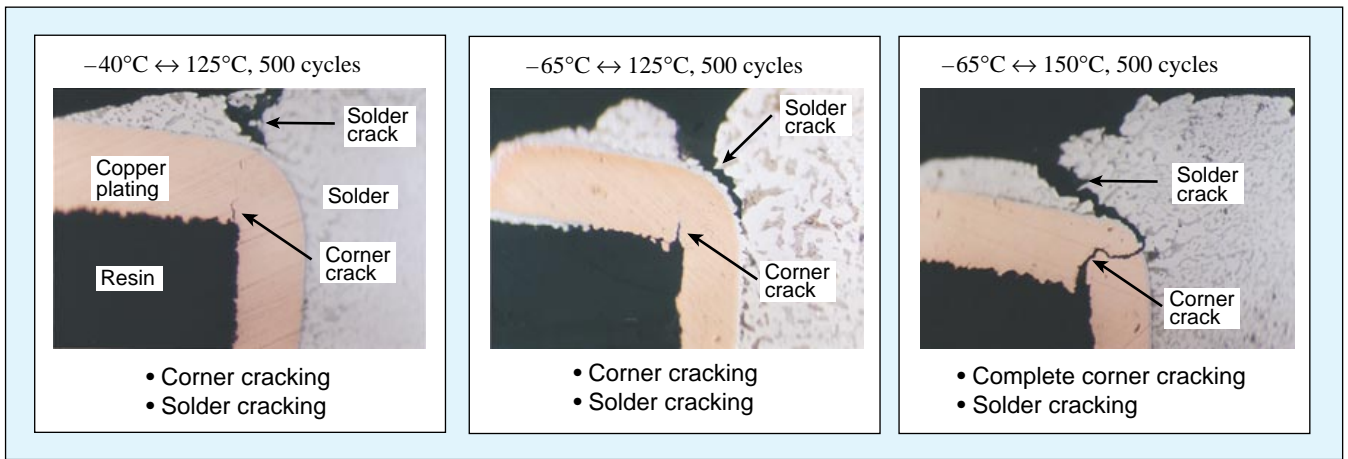

Photo. 2 Cross section observation results (500x)

### 3-3 Differences Due to Temperature Change Time

To compare differences caused by temperature change time, we performed the Temperature Cycle Test (air chamber method) and the Thermal Shock Test (liquid bath method). Fig.5 shows the change in conductor resistance values. Observing the cross sections indicates that the failure mode is corner cracking in both tests, but deformation of the copper plated section occurs in the Thermal Shock Test, leading us to assume strong stress. (Photo. 3)

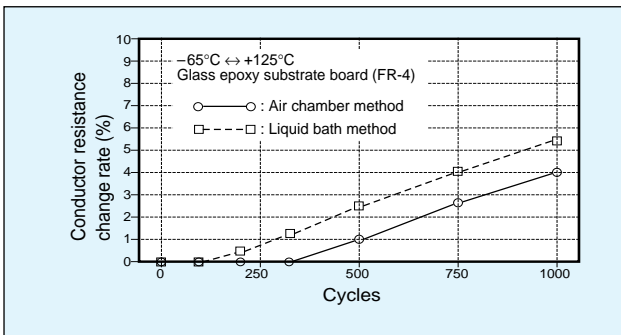

Fig. 5 Changes in conductor resistance due to air chamber method and liquid bath method

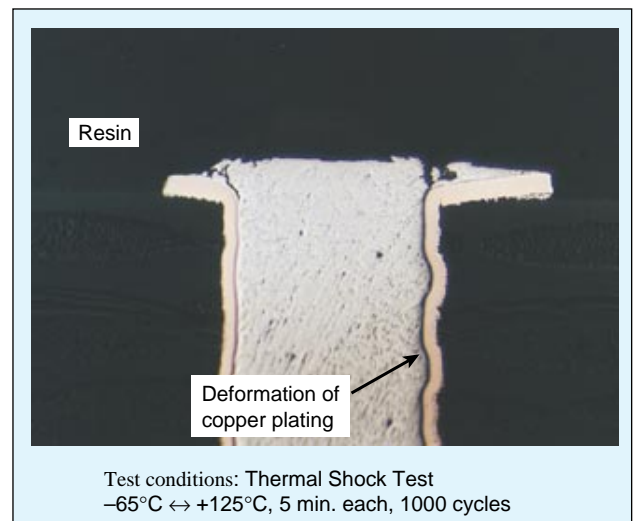

Photo. 3 Results of cross section observation (100x)

## 4. Discussion

In this series of testing, cross section observation clearly showed cracking occurring in the solder in cases of corner cracking of the copper plated through holes which broke completely through. Furthermore, in specimens in which the solder fillet (the solder section filling the junction angle) is high and solder cracking did not occur, corner cracking did not break completely through. From these results, we can assume that a strong relationship exists between solder and the life of copper plated through holes, and that by suppressing solder cracking, through hole reliability can be improved.

Table 2 shows the configuration of the printed circuit board and the coefficient of thermal expansion for each material. Differences in thermal expansion coefficients for the different materials causes stress in response to the temperature cycles to be concentrated on the solder and the corner sections as shown in Fig.6.<sup>3)</sup> When strong stress is repeatedly applied in this area, cracking occurs. Furthermore, during the initial period, cracking

occurs in the copper plating before occurring in the solder.

Table 2 Coefficient of thermal expansion for each material

Material	Coefficient of thermal expansion (ppm/°C)
Copper	17
Solder	24 – 25
Glass epoxy (xy axis)	13 – 18
Glass epoxy (z axis)	110 – 250

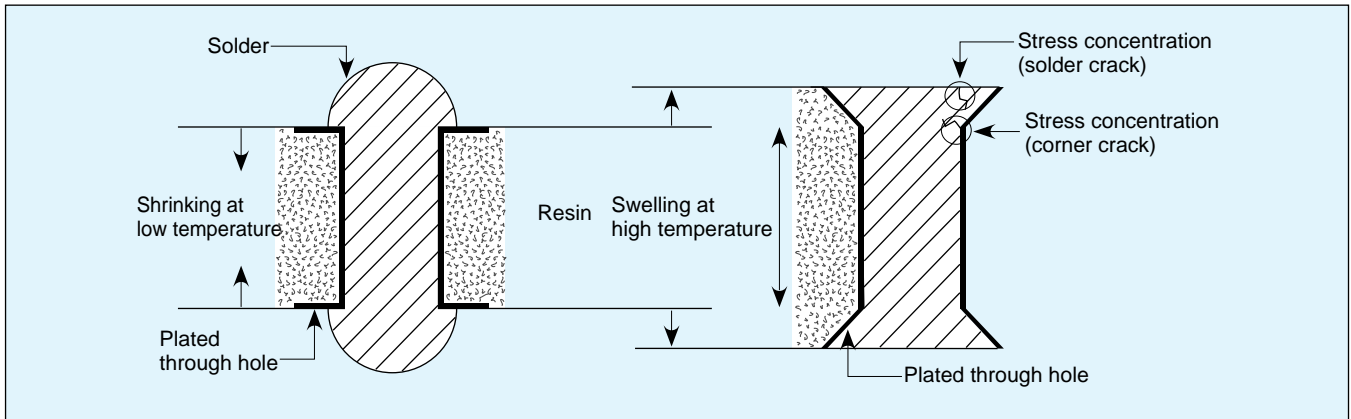

**Fig. 6 Deformation of through hole due to temperature cycle**

However, due to high temperature and stress the solder also sustains roughening of the intergranular boundary, loses shear force and tractive force, and finally ruptures. Then, the stress is concentrated in the corner, promoting cracking and leading to a complete break. Photo. 4 shows this process.

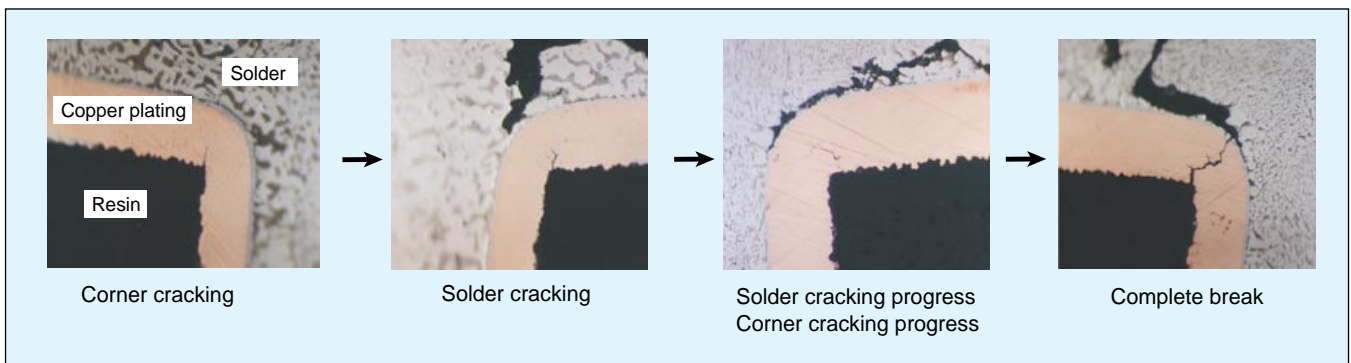

**Photo. 4 Corner cracking process (500x)**

## 5. Conclusion

This investigation led to the following conclusions.

- 1) Failure of plated through holes on PCB is mainly due to corner cracking. This can be confirmed using the Temperature Cycle Test (air chamber method) and Thermal Shock Test (liquid bath method).
- 2) Corner cracking is strongly related to solder cracking, and so through hole reliability can be improved by suppressing cracking.
- 3) We were able to confirm that the greater the test temperature difference, and the faster the temperature change time, the faster the through hole degradation.

In this investigation, we were able to confirm through cross section observation that through hole degradation is related to solder cracking, but we have not yet been able to analyze the statistical data for the relationship.

Moreover, investigation must be continued to determine how through hole degradation and solder cracking are related to changes in conductor resistance.

## [Reference Bibliography]

- 1) Seizo Tanaka, Tomoaki Shimizu: "Reliability Evaluation by Temperature Cycle Tests of Through-hole Boards", Proceedings of the 11th. Union of Japanese Scientists and Engineers Symposium on Reliability and Maintainability (1981)
- 2) Masako Horimoto, Isao Akaishi, Tamotsu Ishikawa, Hirofumi Murata, Akio Yoshida (Matsushita Electronic Components Co., Ltd.): "A Study on a Method of Predicting the life of PTH", Proceedings of the 22nd. Union of Japanese Scientists and Engineers Symposium on Reliability and Maintainability (1992)
- 3) Toshiki Sasabe (Digital Equipment Corporation Japan): "Plating Technology of Printed Wiring Boards", Nikkan Kogyo Surface Mounting Technology (1993)

# The Mechanism of Solder Cracking

Hirokazu Tanaka\*/Yuuichi Aoki\*/Shigeharu Yamamoto\*

*Soldered jointings are indispensable to high-density surface mounting of electronic equipment. Maintaining the reliability of soldered jointings is going to become a major problem that must be overcome to accurately mount miniaturized electronic parts. These soldered jointings deteriorate with exposure to long-term heat and mechanical stress, causing cracking which leads to part failure. In this paper we shall report on reliability testing to confirm the mechanism of solder cracking due to heat stress.*

## 1. Introduction

Many problems exist in relation to soldering reliability, but in this report we shall deal with analyzing the solder cracking mechanism caused by heat cycles. Improving reliability has become vital due to the increase in the number of soldered jointings and recent high-density surface mounting.

When observing a cross section of solder cracking that generally occurs in the field, we can confirm that the particles of each phase of Sn (tin) and Pb (lead) have roughened when compared to the initial soldered jointings. This roughening phenomenon can be confirmed by heating solder to high temperatures and by storing long-term at room temperature.<sup>1)</sup> Furthermore, in cracking occurring in a jointing interface with Cu (copper), only Pb leaves any significant residue on the jointing interface. This is because at high temperatures the dispersing of Sn toward Cu is accelerated, and only Pb remains on the jointing surface, causing a degradation of jointing strength. Considering these factors, we performed the High Temperature Storage Test, the Temperature Cycle Test (air chamber method), and the Thermal Shock Test (liquid bath method) to investigate the effects of high temperatures, and the effects of heat stress due to the temperature cycle.

We would like to report our confirmation of the solder cracking mechanism. According to the results of those tests, the crystallization of solder is changed by heat and stress, resulting in the degradation of mechanical characteristics.

## 2. Solder and Solder Cracking

Solder is an alloy of Sn (tin) and Pb (lead). This combination forms a eutectic alloy particularly well-suited to jointing due to such characteristics as viscosity, flowability, and melting point. When solder is cooled from the liquid phase and reaches crystallization point, it crystallizes in two solid phases, the Pb-rich  $\alpha$  phase, and the Sn-rich  $\beta$  phase.<sup>2)</sup> Immediately after the jointing solidifies, these two phases are uniformly distributed as small particles. When the jointing is with Cu, such as a printed circuit board pattern, the Sn in the solder is dispersed (intergranular dispersion) within the Cu granular boundary, and forms a jointing by making an intermetallic compound. This solder jointing deteriorates due to long-term heat and mechanical stress, resulting in such phenomena as solder cracking. (Photo. 1, a and b). To confirm this failure mechanism, we performed reliability testing on the effects of heat stress.

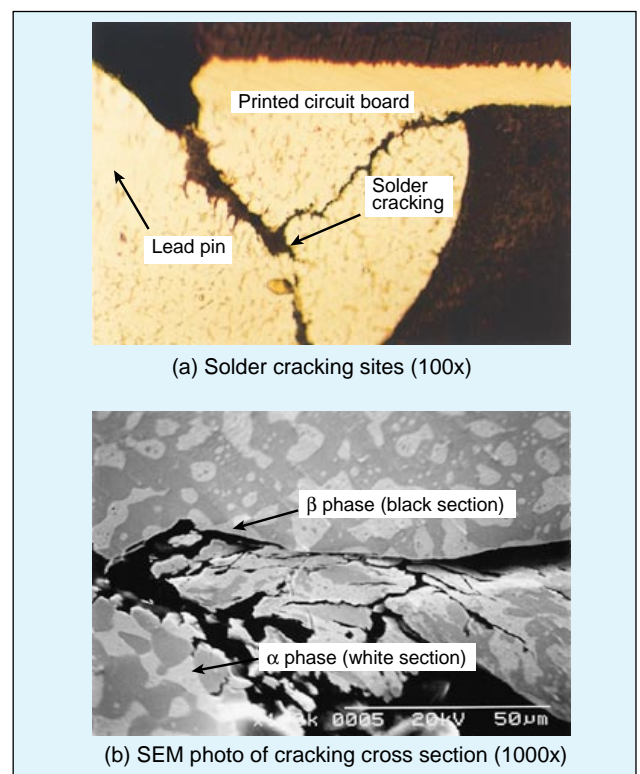

Photo. 1 Cross sectional view of solder cracking

\* Environmental Test Technology Center

### 3. Reliability Testing Results

Table 1 shows testing conditions. A phenol substrate board with one paper surface was used as a specimen. Testing was begun by dipping a lead pin section with copper covered with Sn or solder plating in solder (63 Sn wt%) at 260°C for 10 seconds. After testing, solder cracking sites were impregnated with resin, cross sectioned, polished, and then observed under an SEM (Scanning Electron Microscope).

**Table 1 Test items and test conditions**

Test Items	Test Conditions
<b>High Temperature Storage Test</b> (Using Tabai High Temperature Chamber model PHH-200)	125°C, 100 hours
	150°C, 100 hours
<b>Temperature Cycle Test</b> (Using Tabai Air-to-Air Thermal Shock Chamber model TSA-70H)	-65°C ↔ +125°C, 500 cycles, 30 minutes each
<b>Thermal Shock Test</b> (Using Tabai Liquid-to-Liquid Thermal Shock Chamber model TSB-5)	-65°C ↔ +125°C, 500 cycles, 5 minutes each

\*Each test name uses EIAJ standards.

#### 3-1 Results of High Temperature Storage Test

Specimens were left under high temperature for either 48 or 100 hours, then removed, cross sectioned, and observed. Results of the observation indicated that under conditions of 150°C for 48 hours the  $\alpha$  phase showed considerable progression in roughening. Observation after 100 hours at 125°C showed that roughening progression had continued. (Photo. 2) From these results we were able to confirm that long-term exposure to high temperature promotes roughening of the  $\alpha$  phase.

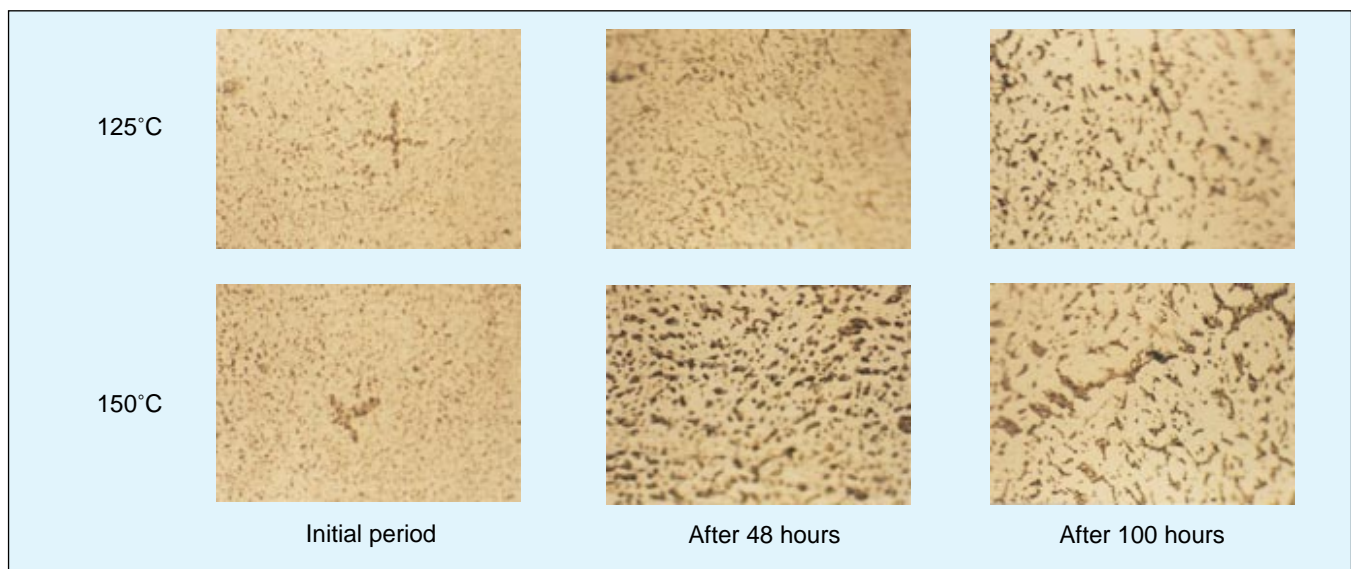

**Photo. 2 Changes in the  $\alpha$  phase during the High Temperature Storage Test (500 $\times$ )**

### 3-2 Results of Temperature Cycle Test

Cracking occurred as in Fig. 1 in the vicinity of the substrate pin hole (section a) and near the lead pin (section b). Using the SEM to observe the section with cracking showed that roughening had occurred in the  $\alpha$  phase, and that those particles had taken a grain-oriented configuration. (Photo. 3) Investigating the cross sectional surface of the cracks revealed surface breaking that showed signs of high stress having been applied, particularly in the surface fractured from the  $\alpha$  phase section. In addition, in the  $\alpha$  phase some sections that have not cracked show a number of micro cracks. (Photo 4)

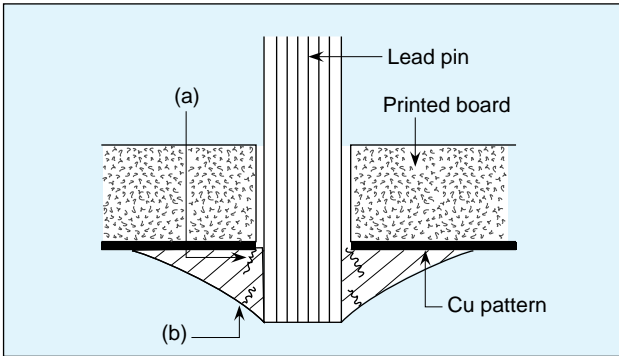

**Fig. 1 Cracking sites resulting from the Temperature Cycle Test**

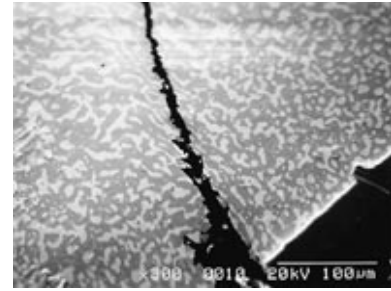

**Photo. 3 Cross section of crack break (300x)**

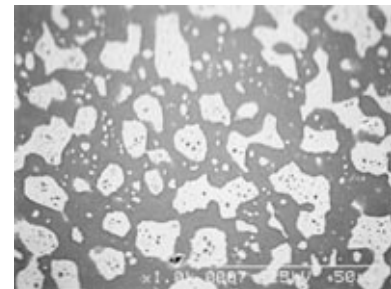

**Photo. 4 Micro cracks in the  $\alpha$  phase (1000x)**

### 3-3 Results of the Thermal Shock Test

A few cracks can also be found in the internal section of the solder, but as seen in Fig. 2, these are at sites where the solder adjoins the lead pin (section a) or the Cu pattern (section b) and are due to separation of the interface. (Photo. 5) In addition, this intermetallic compound alloy has become thickened, and we can assume that the dispersion of Sn has progressed. Unlike the Temperature Cycle Test, no micro cracking occurred.

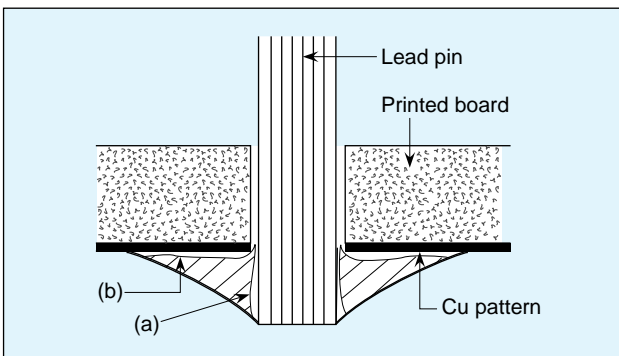

**Fig. 2 Checking sites due to the Thermal Shock Test**

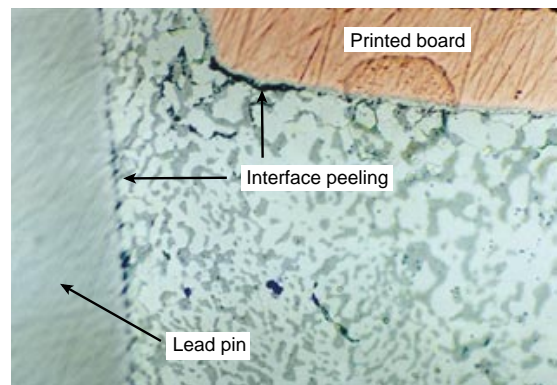

**Photo. 5 Cross section of interface peeling (200x)**

## 4. Discussion of the Solder Cracking Mechanism

In general, the crystalline (eutectic) condition of the solder jointing sections is in the form of small particles in the initial period after the solder is applied. This condition excels in mechanical characteristics, and softens in response to stress, but if left a long time, melting and dispersal gradually occur, and the particles get larger. High temperature and stress promote this dispersal. Solder that has undergone these changes has experienced degradation of its mechanical characteristics. In other words, this solder performs with the individual characteristics of Sn and Pb.<sup>1), 5)</sup>

Using Table 2 to compare the characteristics of Sn and Pb with solder shows that both their shear force and tractive force are considerably less. Also, the grain boundary in each phase is rougher, so the intergranular junction surface becomes broader. At this point, repeatedly applying strong stress causes cracking. Below, we shall discuss this cracking process as it occurs in the Temperature Cycle Test and the Thermal Shock Test.

**Table 2 Characteristics of solder Sn and Pb** <sup>3), 4)</sup>

Characteristics	Unit	Solder 60 Sn wt%	Sn	Pb
Tractive force	kg/mm <sup>2</sup>	5.4	1.5	1.4
Shear force	kg/mm <sup>2</sup>	3.47	2.02	1.39
Stretching	%	30	55	39

### 4-1 Cracking Mechanism in the Temperature Cycle Test

- 1) When leaving at high temperature, the dispersion of Sn progresses, and  $\alpha$  phase (Pb) roughening occurs.
- 2) The temperature cycles apply repeated stress to the solder jointings due to the differences in the heat expansion coefficients of solder, the lead pin, and the printed circuit board.
- 3) The  $\alpha$  phase undergoes elongation stretching in the direction of stress, and micro cracking occurs to alleviate the stress.
- 4) Because the grain boundary in each phase is rougher, the joining strength of the Sn and Pb jointing interface deteriorates in response to stress.
- 5) Because of this, the grain boundary ruptures, after which micro cracking occurs, causing degradation of the shear force, and the solder cracking phenomenon can be seen in the  $\alpha$  phase as well. (Fig. 3)

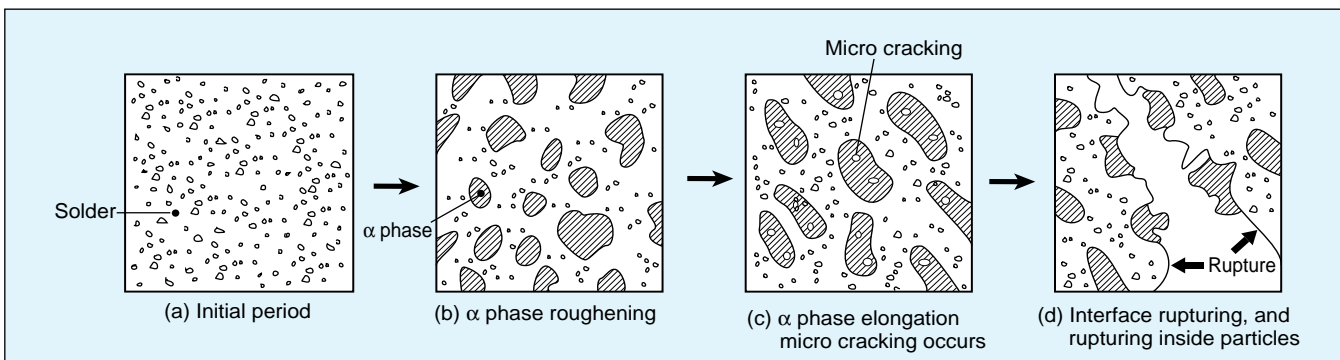

**Fig. 3 Cracking process caused by Temperature Cycle Test**

## 4-2 Cracking Mechanism in the Thermal Shock Test

- 1) The thermal conductivity of the liquid medium is higher than in the air chamber method, so under high temperatures the dispersing of Sn toward metals such as Cu progresses, and the surface of the intermetallic compound (Cu-Sn alloy) is in the  $\alpha$  phase (Pb).
- 2) The temperature cycles apply repeated stress to the solder jointings due to the differences in the heat expansion coefficients of solder, the lead pin, and the printed circuit board.
- 3) Due to the abrupt temperature changes, strong stress is applied to the  $\alpha$  phase of the intermetallic compound, and rupturing and interface peeling occur. (Fig. 4)

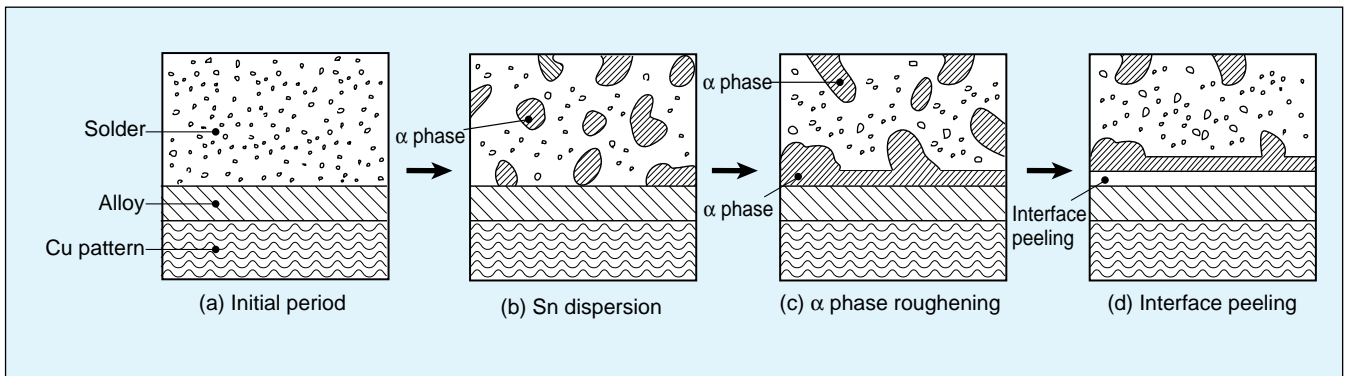

Fig.4 Cracking process caused by Thermal Shock Test

## 5. Conclusion

In this report, we have presented our findings on the solder cracking mechanism due to heat stress. These results indicate that the Temperature Cycle Test (air chamber method) and the Thermal Shock Test (liquid bath method) are effective methods of evaluating solder reliability. However, since the failure modes differ, we can assume that the evaluation points also differ.

- 1) Temperature Cycle Test (air chamber method)  
Cracking occurs inside the solder, and this test is an effective method of evaluating degradation of solder characteristics.
- 2) Thermal Shock Test (liquid bath method)  
Cracking occurs on the PCB pattern and soldered jointings of lead pins, and this test is an effective method of evaluating the condition of the soldered junction.

### [Reference Bibliography]

- 1) Seiichi Matsushige, Hiroshi Nakayama, Kimitoshi Murata (Toyota Motor Corp.): "Concept of Accelerated Life Test", Proceedings of the 21st. Union of Japanese Scientists and Engineers Symposium on Reliability and Maintainability (1991)
- 2) "Metallurgy of Soldered Joint in Electronics", International Tin Research Institute (1992)
- 3) Wakichi Tanaka: "Soldering Technology", Sogo Denshi Shuppan (1974)
- 4) National Astronomical Observatory: "Chronological Scientific Tables", Maruzen Co., Ltd. (1992)
- 5) Masataka Nishiura (Matsushita Electronic Components Co., Ltd.), Shigeo Shiomi (National Development Agency of Japan): "A Study on the Reliability of Soldering of Surface Mount Devices (4)", Proceedings of the 22nd. Union of Japanese Scientists and Engineers Symposium on Reliability and Maintainability (1992)

### 1. Introduction

Shigeru Taniguchi\*

Instrumentation to control and maintain the accuracy of measuring equipment plays a crucial role in all production development.

At Tabai Espec, we produce and market environmental testing equipment used mainly for product quality control. From the time our company was established we have placed major emphasis on instrumentation control of measuring equipment used in instruments mounted on our environmental testing equipment and used to test performance. One aspect of our instrumentation activity has been our effort to establish traceability for domestic standards. In addition, due to the popularization in recent years of the ISO 9000 series, as well as the revision of the Pharmaceutical Law, Tabai Espec has increasingly received calibration requests from customers for testing equipment and measuring equipment. These circumstances prompted our initiating the Tabai Espec traceability service in earnest from 1994.

The term traceability service is used to mean “calibrating environmental testing equipment and every type of measuring equipment for the customer”.



Note:

**Definition of traceability:**

Continually calibrating standard equipment or measuring equipment with a higher and higher level of measuring standards, and establishing a route to connect domestic standards with international standards.

**Definition of calibration:**

Using standard equipment and standard materials to find the relationship of the display value of measuring equipment to the true value.

### 2. Traceability Service (Currently available only in Japan)

Export models of environmental testing equipment and attached measuring instruments are calibrated (fee charged) only for new products before shipping. We are currently developing plans to make our traceability service available overseas as well.

#### 2-1 Features of Our Traceability Service

Putting to best use the know-how we have developed as an environmental testing equipment manufacturer, we not only calibrate environmental testing equipment but also check equipment performance upon customer requests. In addition, in the unlikely event that a defect should be detected in an Espec product, we make repairs. We perform traceability service at our Environmental Testing Technology Centers (Fukuchiyama Test Site and Utsunomiya Test Site) and at service centers throughout Japan. In particular, the Environmental Testing Technology Center has authorized the first privately-owned IECQ independent test site based on ISO/IEC guideline 25. At that test site, calibrating and testing technology is publicly sanctioned. On-site traceability service is performed for the customer by staff members who have successfully completed the company skills verification program.

#### 2-2 Traceability of Environmental Testing Equipment

At present there is still no “domestic standard” for environmental testing equipment, so each company must set and confirm individual standards. In the Espec Group, when no particular specification exists, we calibrate equipment in conformance with the following JTM standards established by the Testing Machinery Association of Japan.

- JTM K 01 -1991  
“Standard for Performance of Humidity Chambers”
- JTM K 03 -1992  
“Standard for Performance of Environmental Temperature and Humidity Rooms”
- JTM K 05 -1991  
“Standard for Performance of High Temperature Chambers”

\* Environmental Test Technology Center



### 2-3 Traceability of Measuring Instruments

In the Espec Group, measuring instruments are handled according to the “Traceability Chart” in Fig. 1. Environmental testing equipment along with attached instruments are calibrated using instrumentation calibrated according to these domestic standards.

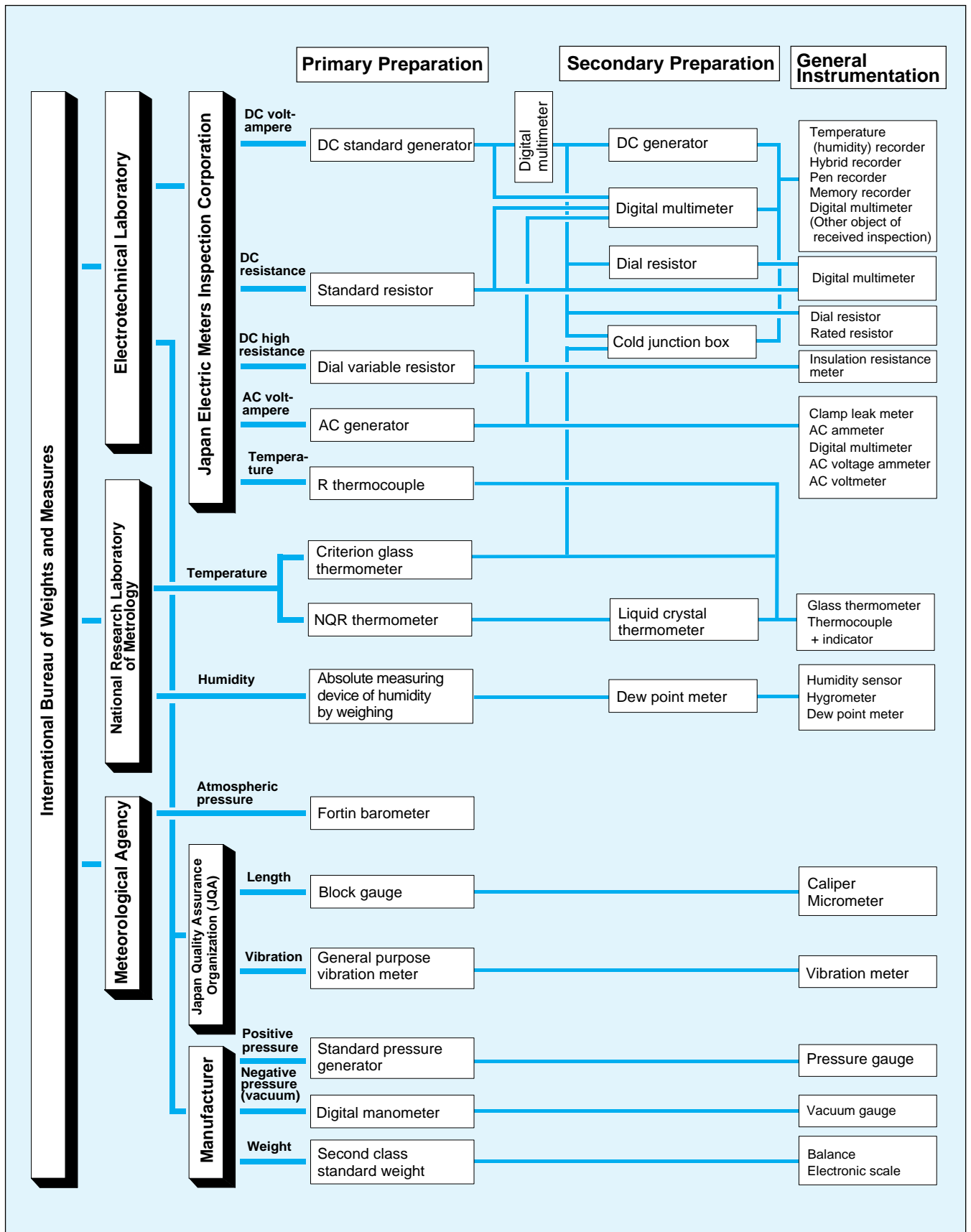

Fig. 1 Traceability Chart

### 2-4 Traceability Service Certification

The following documents can be prepared upon request to certification traceability service results for the ISO 9000 Series:

- Calibration Report (calibration results)
- Calibration Sheet (published by Tabai Espec)
- A copy of the certificate published by a national agency (related to national standards legal requirements)

This service is available not only for new products but also for products that have already been delivered to the customer. We can make on-site service calls to perform calibration.

### 2-5 Products for which Traceability Service is Offered

Products qualifying for traceability service include all of Tabai Espec's environmental testing equipment and attached instrumentation. However, for products of other companies that use Tabai Espec's calibration method, we will confer with the customer about performing this service.

### 2-6 Types of Calibration Currently Performed

#### Temperature (humidity) accuracy for environmental testing equipment

Temperature (humidity) accuracy is determined by the difference between the setting temperature (humidity) of the environmental testing equipment and the reproduced temperature (humidity) inside the test chamber. (Measurement is made at the center of the test area.)

#### Temperature (humidity) fluctuation (adjustment range) of environmental testing equipment

This indicates the range of temperature (humidity) fluctuation over time, measured at the center of the test area of the environmental testing equipment.

#### Temperature (humidity) uniformity of environmental testing equipment

The temperature (humidity) uniformity refers to the difference between the temperature (humidity) at the center of the test area and predetermined other points inside the test area of the environmental testing equipment.

#### Accuracy of instrumentation attached to the environmental testing equipment (e.g., temperature controllers and temperature recorders)

## 3. Calibration Examples

### 3-1 Calibrating Measuring Equipment

In accordance with the prior level standards (liquid crystal thermometer for secondary standard equipment) we shall perform comparative calibration for the thermocouple and temperature recorder used to calibrate environmental testing equipment and attached measuring equipment.

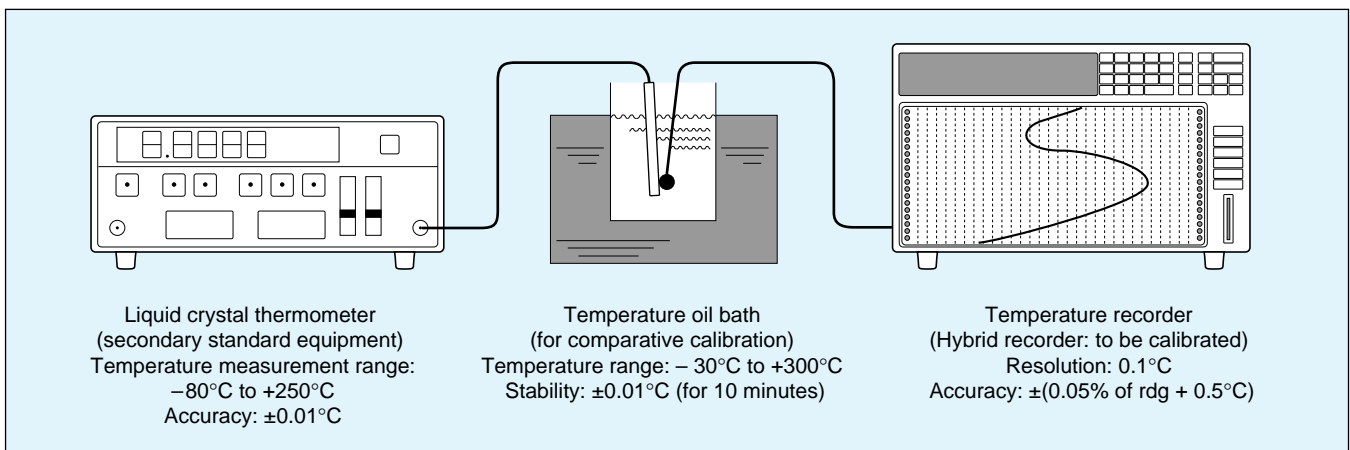

Fig. 2 System for calibrating measuring equipment used for calibration

### 3-2 Temperature (Humidity) Accuracy of Environmental Testing Equipment

Temperature (humidity) shall be measured and calibrated with the temperature recorder calibrated previously in item 3-1 by setting a thermocouple in the geometric center of the test area of the environmental test equipment to be calibrated. Humidity is calibrated with the wet/dry bulb measurement method using a thermocouple, due to such factors as stability, ease of traceability, and maintaining the temperature and humidity calibration range. There are many hygrometer formulas used to calculate relative humidity from the measured temperature (dry bulb temperature and wet bulb temperature), but to conform to JIS and JTM, the following formulas are used:

- Sprung formula (for use when wind speed min. 2.5 m/s)
- Pernter formula (for use when wind speed negligible)

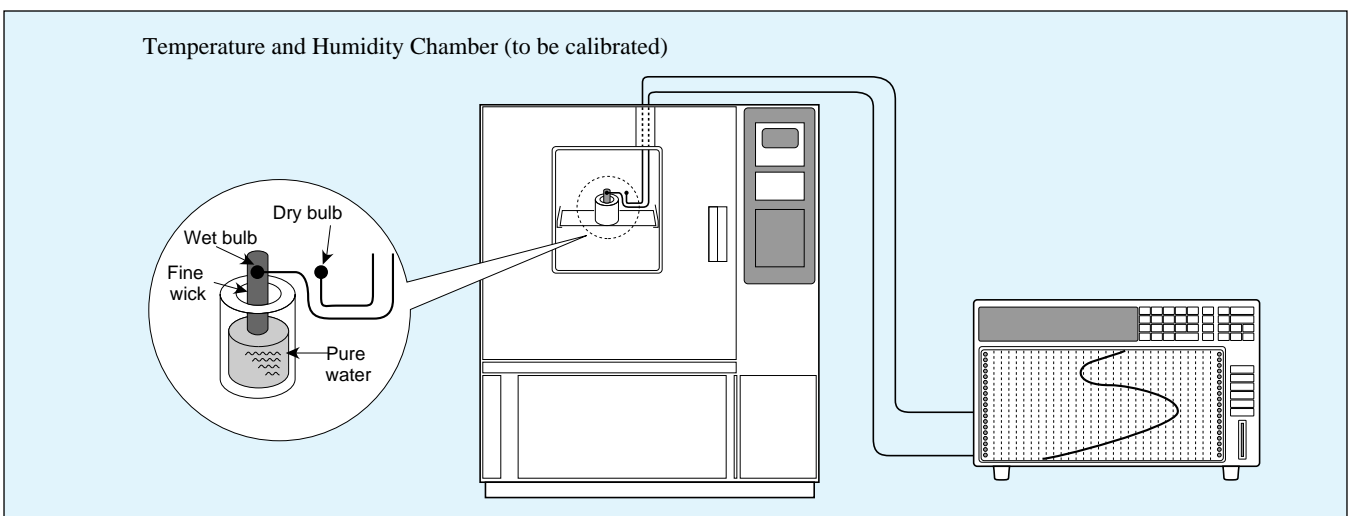

Fig. 3 Example of calibration system for environmental testing equipment

## 4. Summary

In November, 1993, the greatly revised Japanese weights and measures law came into effect, and a new traceability system was formed. This traceability system is a calibration agency authorization system and a weights and measures standard supply system in which calibration agencies specified or authorized by the government are permitted to perform calibration service using standard instruments that have been calibrated according to the national weights and measures standards. Tabai Espec is committed to developing personnel authorized for temperature and humidity in this system, and we are instituting the following plans.

- We are promoting preparations for personnel to acquire temperature authorization for resistance thermometer bulbs (0 to 200°C) as well as glass thermometers (0 to 200°C).
- For humidity, the traceability system is still at the start-up level, and Tabai Espec is participating in a workshop of humidity standards and making every effort to contribute to the development of humidity standards.

In these ways, we at Tabai Espec are striving to enlarge the domain of traceability service while improving quality. Our sincere desire is that these efforts will meet the needs of the customer.

For our overseas customers who are using our environmental testing equipment, we already have the capacity to calibrate temperature (humidity) accuracy at some of our overseas service centers, and in addition to our current overseas service seminars, we are developing a plan for introducing an overseas traceability education system. We are also considering how best to establish a skills examination system to sanction IECQ independent laboratory personnel as well as service personnel of the same level trained in environmental testing control technology.

We plan to station required personnel who have successfully completed the skills examination system outlined above in China by the summer of 1997. We are obtaining cooperation from our service agents in other regions as well, and are making every effort to be able to present a higher level of traceability service covering a much wider region.

**Pub. Date:** April 1, 1997 (biannual)  
**Publisher:** **TABAI ESPEC CORP.**  
 3-5-6 Tenjinbashi, Kita-ku, Osaka 530, Japan

■ *Please direct inquiries regarding this publication to...*

Office of the editor, "ESPEC Technology Report",  
 TABAI ESPEC CORP.  
 Phone: (81) 6-358-4785 Fax: (81) 6-358-4786

■ *Download back numbers from ESPEC homepage*

<http://www.espec-obd.com/>

Copying or reproducing articles from this magazine in any form is prohibited.

**TABAI ESPEC CORP.**

**Head Office (JAPAN)**  
 3-5-6, Tenjinbashi, Kita-ku, Osaka 530, Japan  
 Phone: (81) 6-358-4741 Fax: (81) 6-358-5500  
 Telex: 05233629 TBI J

**Kuala Lumpur Representative Office (MALAYSIA)**  
 Temp Girl Business Center 4th. Floor  
 Secondary Tower Block Wisma MCIS, Jalan Barat  
 46700 Petaling Jaya, Selangor, Malaysia  
 Phone: (60) 3-7544277 Fax: (60) 3-7544290

**Beijing Office (CHINA)**  
 2 Xin Yuan Nan Lu,  
 Chao Yang District, Beijing, China  
 Phone: (86) 10-65941382 Fax: (86) 10-65941383

**Guangzhou Office (CHINA)**  
 1 Zhu Si Gang, Dong Guan Zhuang Road,  
 Guangzhou, China  
 Phone: (86) 13-92206953 Fax: (86) 20-87725041

**ESPEC CORP. (U.S.A.)**  
 425 Gordon Industrial Court, S.W.  
 Grand Rapids, MI 49509, U.S.A.  
 Phone: (1) 616-878-0270 Fax: (1) 616-878-0280

**SHANGHAI ESPEC ENVIRONMENTAL EQUIPMENT CORP. (CHINA)**

Ha-mi Road 166 Shanghai, China  
 Phone•Fax: (86) 21-62394953

**GUANGZHOU ESPEC ENVIRONMENTAL EQUIPMENT CO., LTD. (CHINA)**

1 Zhu Si Gang, Dong Guan Zhuang Road,  
 Guangzhou, China  
 Phone: (86) 20-87745111 Fax: (86) 20-87745223

**C&E ENVIRONMENTAL TECHNOLOGY CO., LTD. (CHINA)**

1 Zhu Si Gang, Dong Guan Zhuang Road,  
 Guangzhou, China

**TABAI ESPEC SERVICE CORP. (JAPAN)**

23-12, Taimahigashimachi, Neyagawa-shi,  
 Osaka 572, Japan  
 Phone: (81) 720-34-1191 Fax: (81) 720-34-7755



JIS Z 9901-1994 JAB Certificate Number  
 Registration Number R001  
 JSAQ 004



**ISO 9001/JIS Z 9901**  
 Quality Management System Assessed and Registered

The Quality Management System of TABAI ESPEC CORP. has been assessed and registered based upon the International Standard ISO9001-1994 and JIS Z 9901-1994, by the Japanese Standards Association (JSA).

**Products or Services:** Development, Design, Production, Installation and Servicing of Environmental Test Chambers, Environmental Test Equipments, Environmental Equipments for Production and Semiconductor Test Equipments.



ISO 14001-1996  
 Approval Certificate No. EC96J1046

**ISO 14001 (JIS Q14001)**  
 Environmental Management System Assessed and Registered

The Environmental Management System at TABAI ESPEC CORP. Fukuchiyama Plant has been assessed and registered based upon the International Standard ISO 14001: 1996 and JIS Q14001: 1996, by Japan Audit and Certification Organization for Environment (JACO).

**Subject to certification:** The design and manufacture of Environmental test equipments and Semiconductor test equipments.

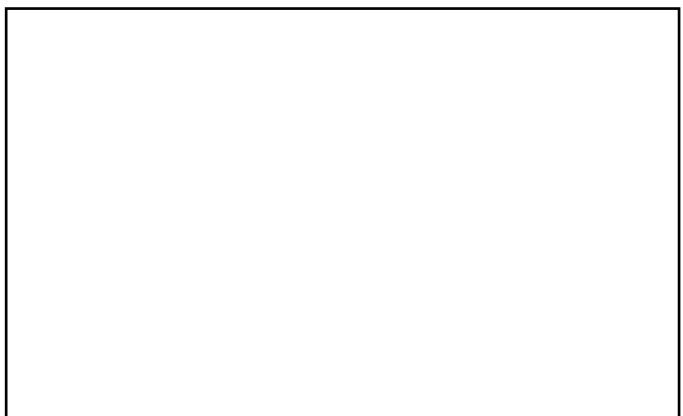

This magazine printed on recycled paper.